

ECHO

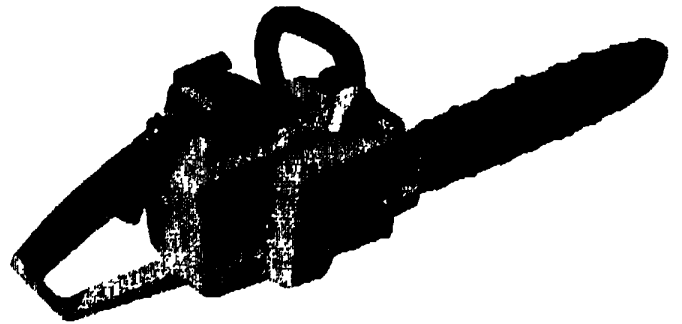

OPERATOR'S MANUAL

**ECHO
CHAIN SAW
CS-315**

CAUTION

Read Rules for Safe Operation
and Instructions Carefully



898 672-1123 7

RULES FOR SAFE OPERATION

1. Never operate a chain saw when you are fatigued.
2. Use safety footwear, snug-fitting clothing, and eye, hearing and head protection devices.
3. Always use caution when handling fuel. Move the chain saw at least 10 feet (3 m) from the fueling point before starting the engine.
4. Do not allow other persons to be near the chain saw when starting or cutting. Keep bystanders and animals out of the work area.
5. Never start cutting until you have a clear work area, secure footing, and a planned retreat path from the falling tree.
6. Always hold the chain saw firmly with both hands when the engine is running. Use a firm grip with thumb and fingers encircling the chain saw handles.
7. Keep all parts of your body away from the saw chain when the engine is running.
8. Before you start the engine, make sure the saw chain is not contacting anything.
9. Always carry the chain saw with the engine stopped, the guide bar and saw chain to the rear, and the muffler away from your body.
10. Never operate a chain saw that is damaged, improperly adjusted, or is not completely and securely assembled. Be sure that the saw chain stops moving when the throttle control trigger is released.
11. Always shut off the engine before setting it down.
12. Use extreme caution when cutting small size brush and saplings because slender material may catch the saw chain and be whipped toward you or pull you off balance.
13. When cutting a limb that is under tension, be alert for spring back so that you will not be struck when the tension in the wood fibers is released.
14. Keep the handles dry, clean and free of oil or fuel mixture.
15. Don't operate the chain saw in such a condition as muffler or muffler screen is removed or the damaged muffler system kept un-repaired. For ECHO chain saws, Fire preventing mufflers (fire arrester screen) are available as optional parts, beside standard mufflers, for purpose of preventing the unforeseen risk of fire. Please do not fail to apply this fire arrester screen when working, surrounded by the inflammable objects like chips, dry grass, etc. during the summer or dry seasons.
16. Operate the chain saw only in well ventilated areas.
17. Do not operate a chain saw in a tree unless specially trained to do so.
18. All chain saw service, other than the items listed in the Operator's Manual maintenance instructions, should be performed by competent chain saw service personnel. (e.g., if improper tools are used to remove the flywheel, or if an improper tool is used to hold the flywheel in order to remove the clutch, structural damage to the flywheel could occur which could subsequently cause the flywheel to burst.)
19. Guard against kickback. Kickback is the upward motion of the guide bar which occurs when the saw chain at the nose of the guide bar contacts an object. Kickback can lead to dangerous loss of control of the chain saw.

TO AVOID KICKBACK:

- Hold the chain saw firmly with both hands. Don't over reach.
- Don't let the nose of the guide bar contact a log, branch, ground or any other obstruction.
- Cut at high engine speeds.
- Don't cut above shoulder height.
- Follow manufacturer's sharpening and maintenance instructions for the saw chain.

PARTS LIST (1)

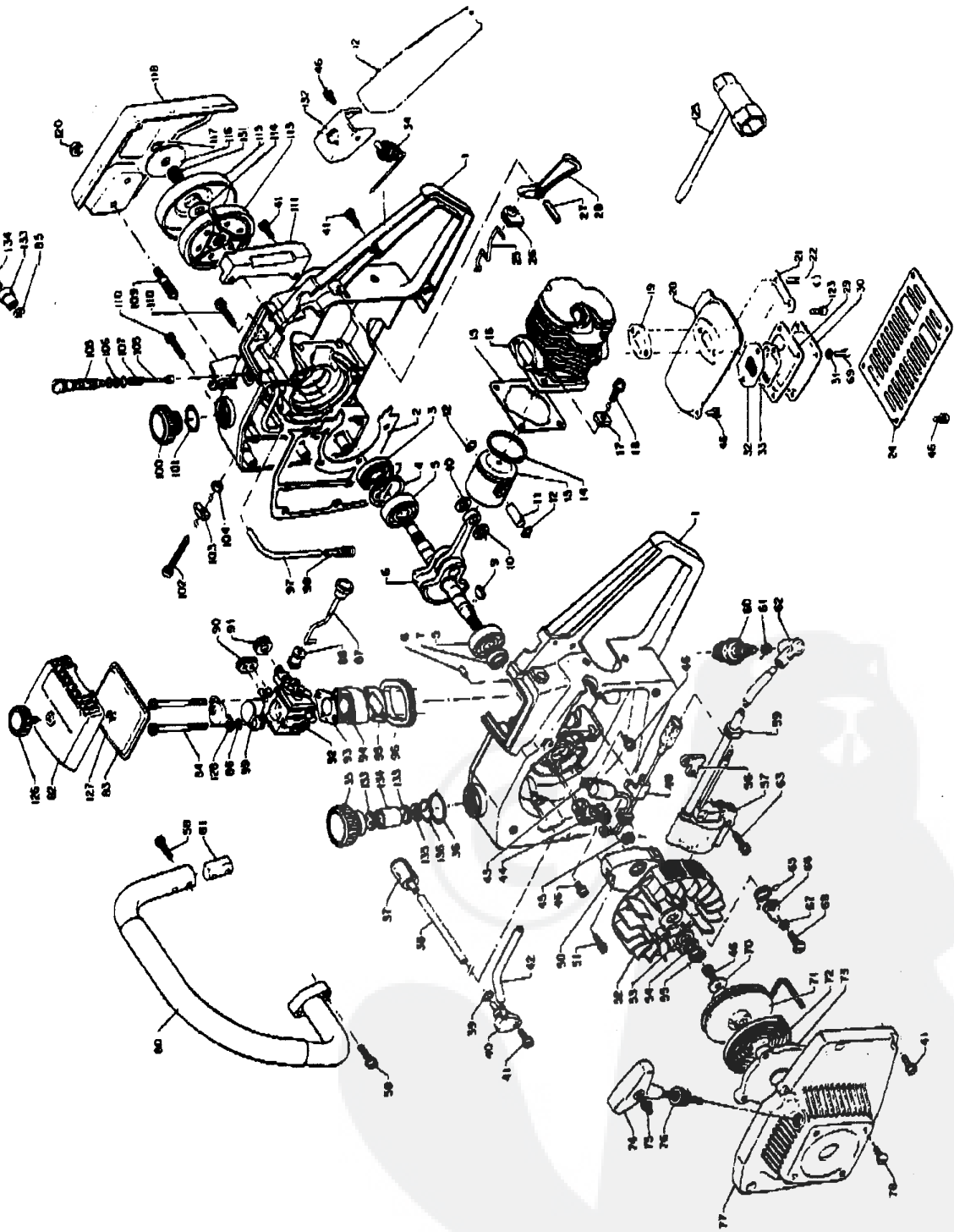

HANDGUARD ASSY 351-805-112-31

Key No.	Part Number	Q'ty	Description	Key No.	Part Number	Q'ty	Description
1	100 200-1123	4	Crankcase set	70	-177 214-0393	0	Washer
2	100 242-1123	0	Gasket-crankcase	71	-177 208-1123	0	Recoll drum <i>DISC.</i>
3	100 213-0393	0	Oil seal	72	-177 220-1123	0	Rowind spring <i>DISC.</i>
4	900 702-0003	2	Circclip 32	73	-177 208-1123	0	Starter case
6	900 610-3620	1	Ball bearing, 6201	74	-177 228-1113	0	Starter handle
6	100 100-1123	1	Crankshaft ass'y	76	-177 226-0393	0	Starter rope
7	100 212-1123	0	Oil seal	76	-177 227-0633	0	Rope guide
8	100 218-0393	0	Knock pin	77	-101 511-1123	1	Fan cover
9	100 131-0162	0	Woodruff key	78	-177 251-1123	0	Screw
10	100 014-1123	0	Spacer-Piston pin	80	361 205-1123	0	Front handle
11	100 013-1123	0	Piston pin	81	391 211-1123	0	Insert-front handle
12	100 018-0483	0	Circclip-Piston pin	82	130 313-1123	1	Cover-air cleaner <i>DISC.</i>
13	100 010-1123	1	Piston	83	130 310-1123	1	Air filter <i>→ 2 holes</i>
14	100 011-1123	0	Piston ring	84	900 162-0505	5	Bolt, 5x65 <i>130-310-112-30</i>
15	101 010-1123	0	Gasket-cylinder base	86	178 616-0083	0	Spacer
16	101 011-1123	1	Cylinder	87	178 610-1123	0	Choke rod
17	100 216-1123	0	Nut	88	178 610-1123	1	Rubber grommet-choke rod
18	900 242-0502	2	Screw, 6x22 w/W, SW	89	129 010-0393	0	Grommet
25	178 011-1123	0	Throttle rod	91	129 023-1113	0	Grommet
26	178 210-1123	0	Rubber Grommet-throttle	92	123 000-1123	1	Carburetor ass'y
27	900 340-6002	5	Spring pin	93	130 016-1123	0	Gasket-carburetor
28	178 010-1123	0	Throttle trigger	94	130 017-1123	0	Insulator
34	163 400-1123	1	Switch	95	130 010-1123	0	Gasket-insulator
35	131 004-0393	1	Cap, fuel tank <i>disc.</i>	96	130 012-1123	0	Grommet-Intake
36	-900 720-0002	2	O-ring 22	97	437 210-1123	0	Oil pipe
133	-131 031-0393	0	Spacer	98	436 205-0283	2	Oil strainer
134	-131 030-0393	0	Supporter	99	178 616-1123	1	Choke shutter
135	-131 035-0343	1	Filter	100, 101	436 001-1113	0	Cap ass'y, oil tank
136	-131 032-0393	0	Clip	100	-436 007-1113	0	Cap, oil tank
37	131 205-0523	0	Fuel strainer	101	-900 720-0001	6	O-ring, 18
38	132 010-1293	0	Fuel pipe-inner	102	900 220-0504	0	Screw, 6x40
39	900 720-0000	7	O-ring 7	103	433 014-1123	0	Tensioner
40	132 011-1123	0	Fuel pipe connector	104	433 022-0283	0	Lock nut, 6
41	900 242-0401	4	Screw, 4x14 w/W, SW	105	437 002-1123	0	Auto. oiler
42	132 012-1123	0	Fuel pipe-outer	106	437 020-0283	0	O-ring
43	156 104-1123	0	Condenser	107	437 019-0283	0	Spring-pump plunger
44	156 101-1123	0	Contact breaker point set	108	433 011-1123	4	Stud bolt-guide bar
45	156 134-0483	0	Oil pad	110	100 244-1123	1	Screw, 4x25 w/W, SW
46	900 242-0401	0	Screw, 4x10 w/W, SW	111	100 618-1123	0	Dust seal plate
48	156 112-1123	0	Clamp	112	351 012-1123	1	Grip-rear handle
50	156 128-1123	1	Breaker cover	113	175 000-0393	0	Clutch ass'y
51	900 240-0301	6	Screw, 3x18 w/W	114	175 015-0393	0	Washer
52	156 205-1123	0	Flywheel	115	175 005-1153	0	Clutch case, w/sprocket
53	900 600-0000	8	Washer, 8	116	175 014-1123	2	Washer
54	900 605-0000	8	Spring washer, 8	117	100 130-1123	0	Snap ring
55	900 602-0000	8	Nut, 8	118	433 010-1123	1	Cover-guide bar - 2 HOLE *
56	150 117-0393	0	Spacer-magneto	120	433 019-0393	2	Flange nut
57	156 108-1123	0	Ignition coil	128	895 410-0393	0	Box wrench, w/screw driver
58	900 242-0402	0	Screw, 4x20 w/W, SW	126	130 406-0393	0	Thumb bolt
59	150 110-0393	0	Rubber grommet-H.T. cord	127	900 700-0000	2	E-ring 2
60	159 010-0039	0	Spark plug	128	130 406-1123	0	Bracket, air cleaner
61	159 011-0243	2	Coil Spring-spark plug cap	131	178 012-0393	0	Needle bearing
62	159 012-0162	0	Cap-spark plug	132	163 610-1123	0	Bracket, switch
63	156 314-1233	0	Screw	133	433 000-1283	0	Chain catcher
65	177 234-0393	1	Ratchet spring	85	-900 600-0000	5	Washer, 6
66	177 218-0393	0	Ratchet	134	-900 242-0502	5	Screw 6x25 w/W, SW
67	177 247-0483	0	Spacer-ratchet				
68	177 217-0483	0	Screw				
**	177 200-1123	1	Recoll starter ass'y				
46	-900 242-0401	0	Screw 4x10 w/W, SW				

* Consisting of 35,38 and 133 thru 136
 ** Consisting of 41 and 70 thru 78

* 1 HOLE GUIDE BAR COVER - 433-010-112-30

PARTS LIST (1) MUFFLER

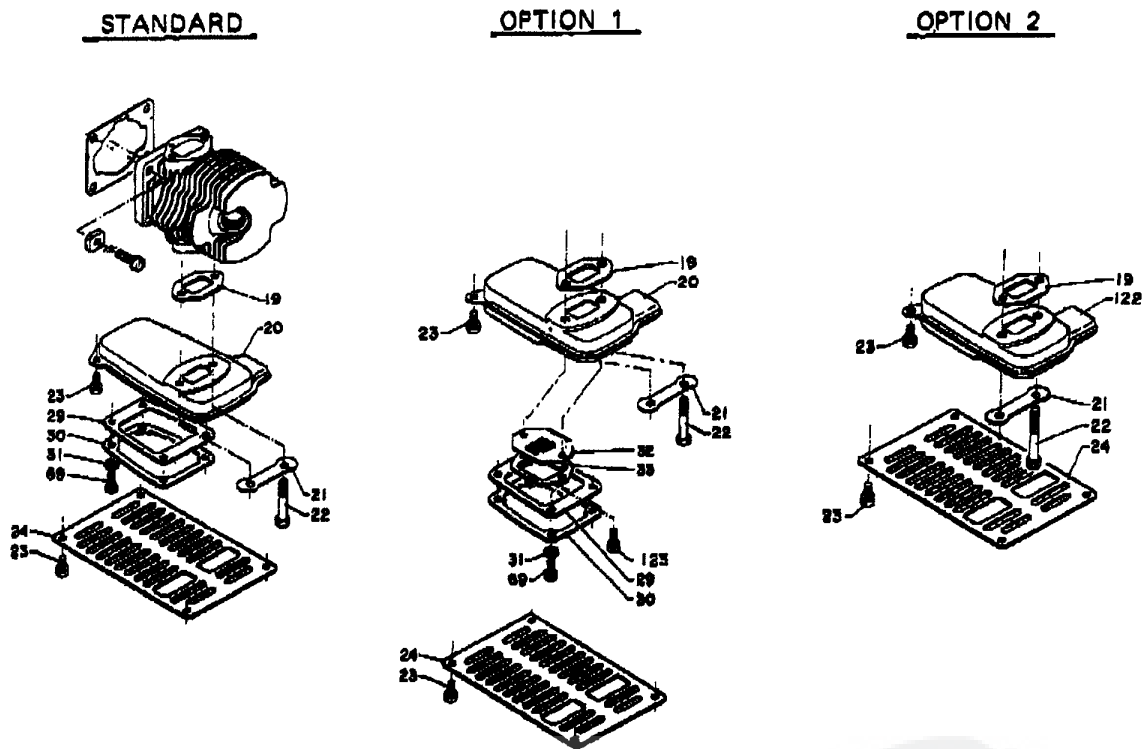

Key No.	Part Number	Description	Quantity per unit		
			STANDARD	OPTION 1	OPTION 2
1- 19	145 610-1123 0	Gasket-muffler	1 PCE	1 PCE	1 PCE
20	145 808-1123 0	Muffler body (S.A.M.)	1	1	1
122	145 610-1123 0	Muffler	—	—	—
21	145 642-1123 0	Washer-muffler	1	1	1
22	900 100-0603 0	Bolt, 5x30	2	2	2
23	800 241-0401 0	Screw, 4x10 w/SW	6	6	6
24	145 921-1123 0	Muffler cover	1	1	1
29	145 888-1123 0	Gasket-muffler lid	1	1	—
30	145 861-1123 0	Muffler lid (S.A.M.)	1	1	—
31	900 610-0000 4	Lock washer, 4	4	4	—
32	145 882-1123 0	Muffler screen (S.A.M.)	—	1	—
33	145 883-1123 0	Screen holder (S.A.M.)	—	1	—
69	900 220-0401 0	Screw, 4x10	4	4	—
123	900 220-0400 8	Screw, 4x8	—	2	—

PARTS LIST (2) CARBURETOR (TYPE: WA - 33)

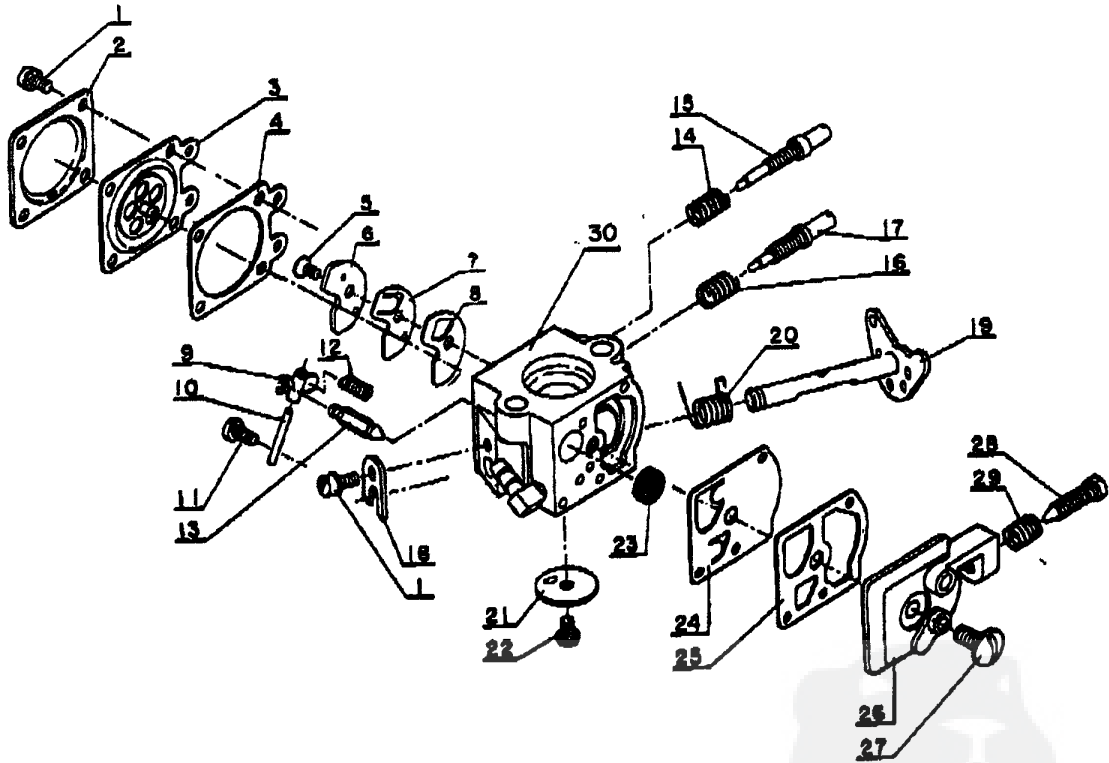

Key No.	Part Number	Q'ty	Description	Key No.	Part Number	Q'ty	Description
2 *	123 000-1123 1	1	Carburetor ass'y	15	- 123 120-1123 0	1	Needle-high speed
1	- 123 144-0393 0	5	Screw	16	- 123 121-0393 0	1	Spring-idle needle
2	- 123 142-0393 0	1	Cover-metering diaphragm	17	- 123 118-1063 0	1	Needle-idle
3	- 123 141-0393 0	1	Diaphragm-metering	18	- 123 127-0393 0	1	Clip-throttle shaft
4	- 123 140-0393 0	1	Gasket-metering diaphragm	19	- 123 117-1123 0	1	Shaft ass'y-throttle
5	- 123 167-0623 0	1	Screw-circuit plate	20	- 123 113-0393 0	1	Spring-throttle return
6	- 123 166-0393 0	1	Plate-circuit	21	- 123 116-0393 0	1	Valve-throttle
7	- 123 165-0393 0	1	Diaphragm-circuit plate	22	- 123 114-0393 0	1	Screw-throttle valve
8	- 123 164-0393 0	1	Gasket-circuit plate	23	- 123 126-0393 0	1	Screen-inlet
9	- 123 123-0393 0	1	Lever-metering	24	- 123 112-0393 0	1	Diaphragm-fuel pump
10	- 123 138-0393 0	1	Pin-metering lever	26	- 123 125-0393 0	1	Gasket-fuel pump
11	- 123 139-0393 0	1	Screw-metering lever pin	28	- 123 124-1113 0	1	Cover-fuel pump
12	- 123 122-0393 0	1	Spring-metering lever	27	- 123 110-0393 0	1	Screw-pump cover
13	- 123 137-0393 0	1	Valve-inlet needle	28	- 123 134-1113 0	1	Screw-idle adjustment
14	- 123 119-0393 0	1	Spring-h.s. needle	29	- 123 133-1113 0	1	Spring-idle screw
				30	NOT AVAILABLE	1	Body ass'y, carburetor

* Consisting of 1 thru 30