

IPL, Contour 500 Power plus, 9648593-25, 9648593-62,
 Contour 700 Power plus, 9648595-25, 9648595-62, 2006-11

This replaces AP0502002 & AP0512006

Contour 500 - 700 Power Plus

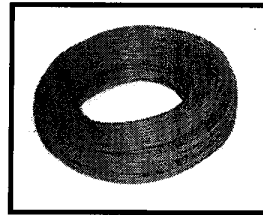

514 84 37-90

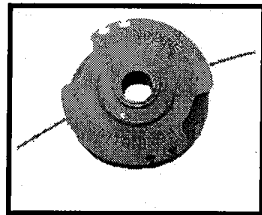

513 93 71-90

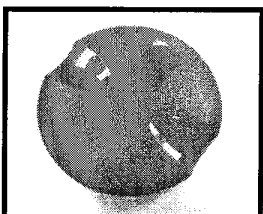

512 82 50-87

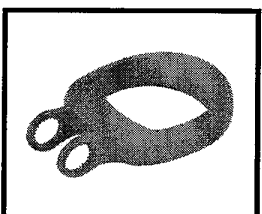

510 73 66-87



510 73 67-87

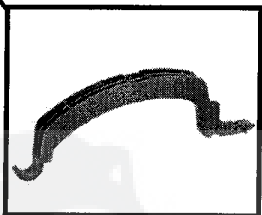

510 73 05-00

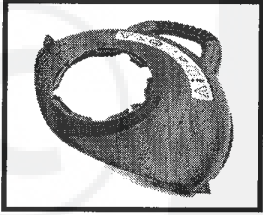

510 73 68-87 (500)
510 73 69-87 (700)

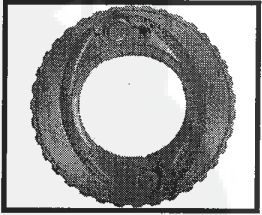

510 73 64-87 (500)
510 73 65-87 (700)

Part Number	Description	Qty	Note
510 73 05-00	Switch Lever	1	
510 73 62-87	Guard 25cm	1	500
510 73 63-87	Guard 30cm	1	700
510 73 64-87	Wheel 25cm	1	500
510 73 65-87	Wheel 30cm	1	700

Part Number	Description	Qty	Note
510 73 66-87	Steady Handle	1	
510 73 67-87	Cutting Head	1	
512 82 50-87	Spool Cover	1	
513 93 71-87	Spool & Line Double Autfeed	1	
514 84 37-87	Nylon Line 20m	1	

Factory:
Product Group:
Sub Group:
Publication Date:
Publication Number:

FLM - Newton Aycliffe
OM 78
Lawn Edger & Trimmer: 7885
02/11/06
AP0611001

solutions

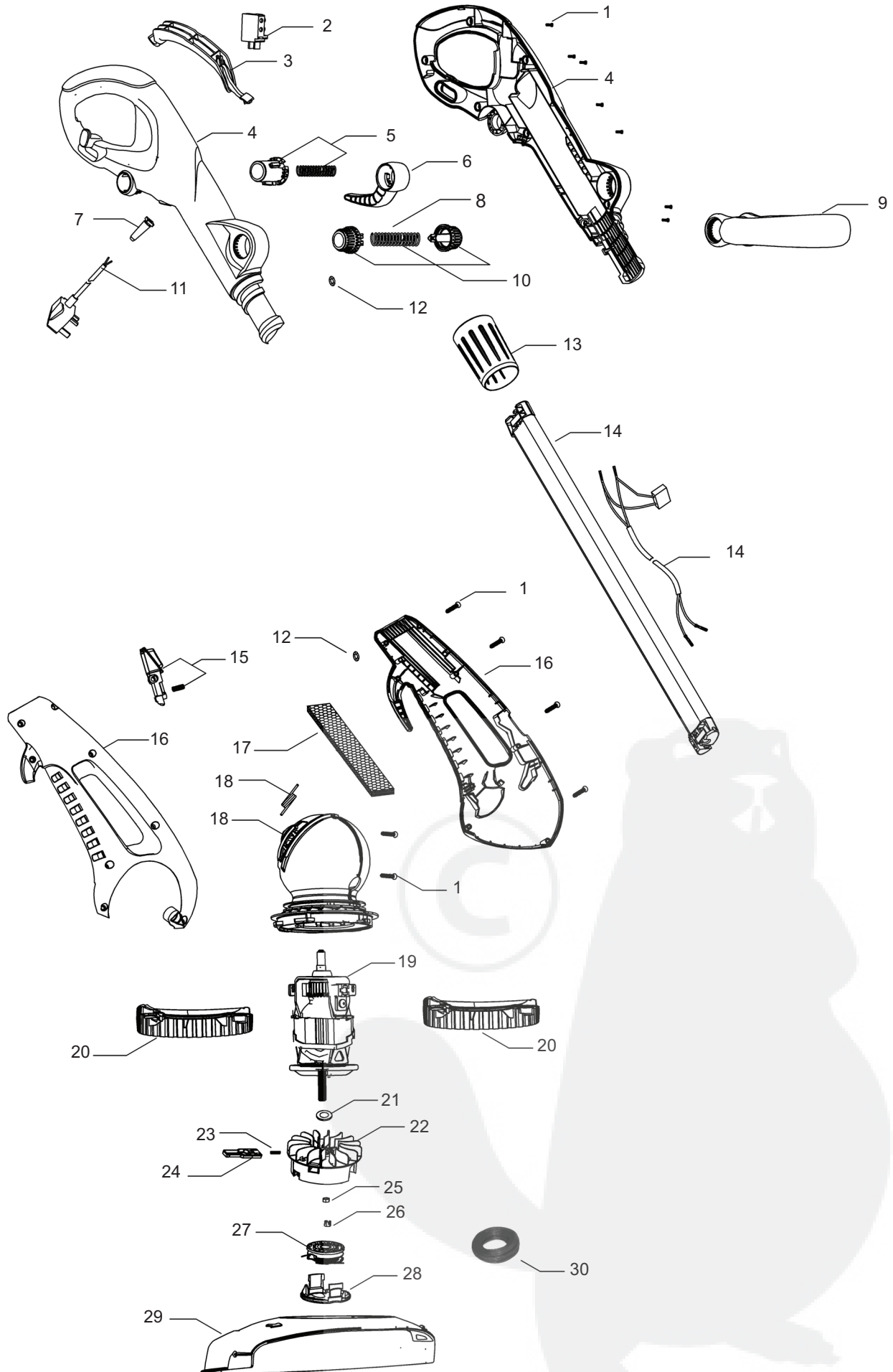

**IPL Flymo Contour 500 Power Plus 9648593-25 9648593-62
Contour 700 Power Plus 9648595-25 9648595-62 2008-08**

Item	PNC	Description	Qty	Notes
1	5219516-01	SCREW PACK (QTY 10)	2	
2	5219512-01	SWITCH	1	
3	5107305-00	SWITCH LEVER	1	
4	5219515-01	HANDLE CLAMSHELLS PAIR	1	
5	5219513-01	CABLE HOOK RELEASE MECHANISM	1	
6	5219514-01	CABLE HOOK	1	
7	5149370-00	CABLE GROMMET	1	
8	5046324-01	HANDLE BUTTON SPRING	1	
9	5107366-87	HANDLE ASSIST	1	
10	5219511-01	HANDLE BUTTON PACK	1	
11	5127251-10	MAINS CABLE UK	1	UK
11	5119711-00	MAINS CABLE EU	1	EU
12	5046317-01	FIXINGS 2 SETS TOP & BOTTOM	1	
13	5046330-01	LOCKING RING	1	
14	5219510-01	SHAFT ASSY	1	
15	5046316-01	RELEASE LEVER ASSY	1	
16	5219500-01	CLAMSHELLS PAIR	1	
17	5046337-01	FILTER (QTY 2)	1	
18	5219502-01	MOTOR HOUSING INCL SPRING	1	Inc Spring
19	5219505-01	MOTOR ASSY	1	500
19	5219506-01	MOTOR ASSY	1	700
20	5107364-87	WHEEL 25CM	1	500
20	5107365-87	WHEEL 30CM	1	700
21	5140266-00	WASHER FOR MOTOR SHAFT	1	
22	5107367-87	SPOOL HOLDER	1	
23	5148940-00	SPRING FOR LINE FEEDER	1	
24	5100859-01	LINE FEEDER	1	
25	5148683-00	NUT	1	
26	5148631-00	INSULATOR CAP	1	
27	5139371-90	SPOOL & LINE	1	
28	5128250-87	SPOOL CAP	1	
28	5107362-87	GUARD 25CM	1	500
29	5107363-87	GUARD 30CM	1	700
30	5148437-90	LINE	1	

