

brand	FLYMO
-------	--------------

date	FEB/04	SHEET 1/2
------	--------	-----------

Model	RE 460
-------	---------------

Product number	9538761-52
----------------	-------------------

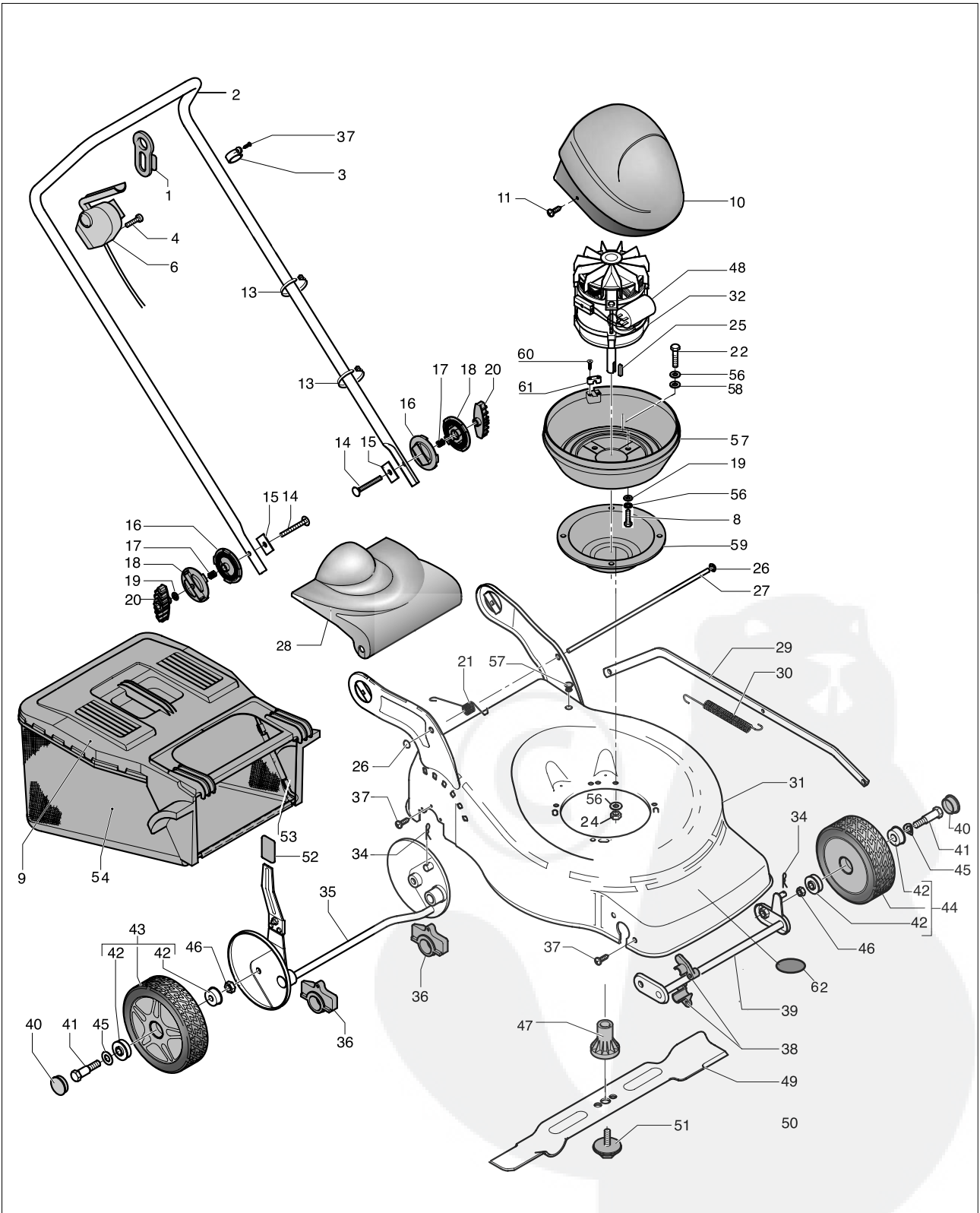

brand **FLYMO**

date FEB-04 SHEET 2/2

Model

RE 460

Product number

9538761-52

Pos.	PN ELX	DESCRIPTION	Q.ty
1	531207051	CABLE HOOK	1
2	531212244	HANDLE	1
3	531207063	LOCK RING	1
4	531207675	SCREW	2
6	531207081	SWITCH	1
8	531208586	SCREW	4
9	531210785	SACK FRAME UPPER	1
10	531212544	DEFLECTOR	1
11	531208216	SCREW	4
13	531205581	CLAMP	1
14	531211480	SCREW	2
15	531211581	PLATE	2
16	531211473	DISK	2
17	531211476	SPRING	2
18	531211474	DISK	2
19	531204922	WASHER	6
20	531205840	KNOP	2
21	531211840	SPRING	1
22	531207071	SCREW	3
24	531207982	NUT	3
25	531207041	KEY	1
26	531210824	WASHER	2
27	531211441	TIE-ROD	1
28	531212541	DEFLECTOR	1
29	531205069	ROD	1
30	531205056	SPRING	1
31	531212611	DECK	1
32	531212656	ENGINE	1
34	531206653	COTTER PIN	2
35	531205100	AXLE	1
36	531205944	SUPPORT	2
37	531208844	SCREW	5

Pos.	PN ELX	DESCRIPTION	Q.ty
38	531205057	SUPPORT	4
39	531205050	AXLE	1
40	531210795	PLUG	4
41	531205042	SCREW	4
42	531205214	BALL-BEARING	4
43	531212634	WHEEL	2
44	531212635	WHEEL	2
45	531206644	WASHER	4
46	531207978	NUT	4
47	531211644	BLADE ADAPTER	1
48	531207070	CAPACITOR	1
49	531211652	BLADE	1
51	531211594	SCREW	1
52	531207986	SHEATING	1
53	531208300	BAG FRAME	1
54	531208306	GRASS CATCHER	1
56	531207981	WASHER	7
57	531205153	PLUG	1
57	531207069	MOTOR HOUSING BOTTOM	1
58	531205552	WASHER	3
59	531207039	SAFETY HOUSING	1
60	531207065	SCREW	2
61	531207043	CABLE LOCK	1
62	531212716	LABEL	1