

3LD450

3LD510

3LD450/S

3LD510/L

LC
FAB
REG
MAI

LOM
FABRI
REGG
MAI

SER
POCH
GAS
DICH
SER
SER
RIC
PIEC
MAI
WAI
REPL

SERI
POCH
GAS
DICH
SERIE
SERIE
RICAT
PIEC
MAIN
WAI
REPL

SERVICE

LOMBARDINI
FABRICA ITALIANA MOTORI S.p.A.
REGGIO EMILIA, ITALIA
MADE IN ITALY

SERIE GUARNIZIONI
POCHETTE JOINTS
GASKET SET
DICHTUNGSATZ
SERIE JUNTAS

RICAMBI PRIMO IMPIEGO
PIECES POUR L'ENTRETIEN
MAINTENANCE SPARE PARTS
WARTUNG - ERSATZTEILE
REPUESTOS DE PRONTO EMPLEO

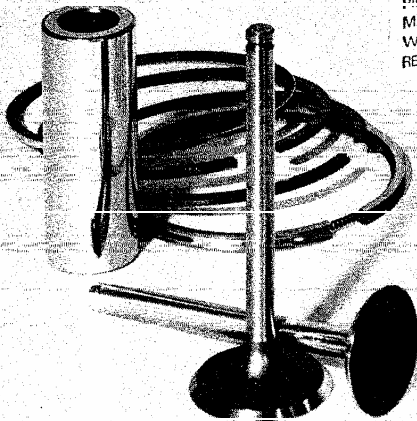

REPUESTOS ORIGINALES
ORIGINAL ERSATZTEILE
GENUINE SPARE PARTS
PIECES D'ORIGINE
RICAMBI ORIGINALI

LOMBARDINI MOTORI

LOMBARDINI MOTORI

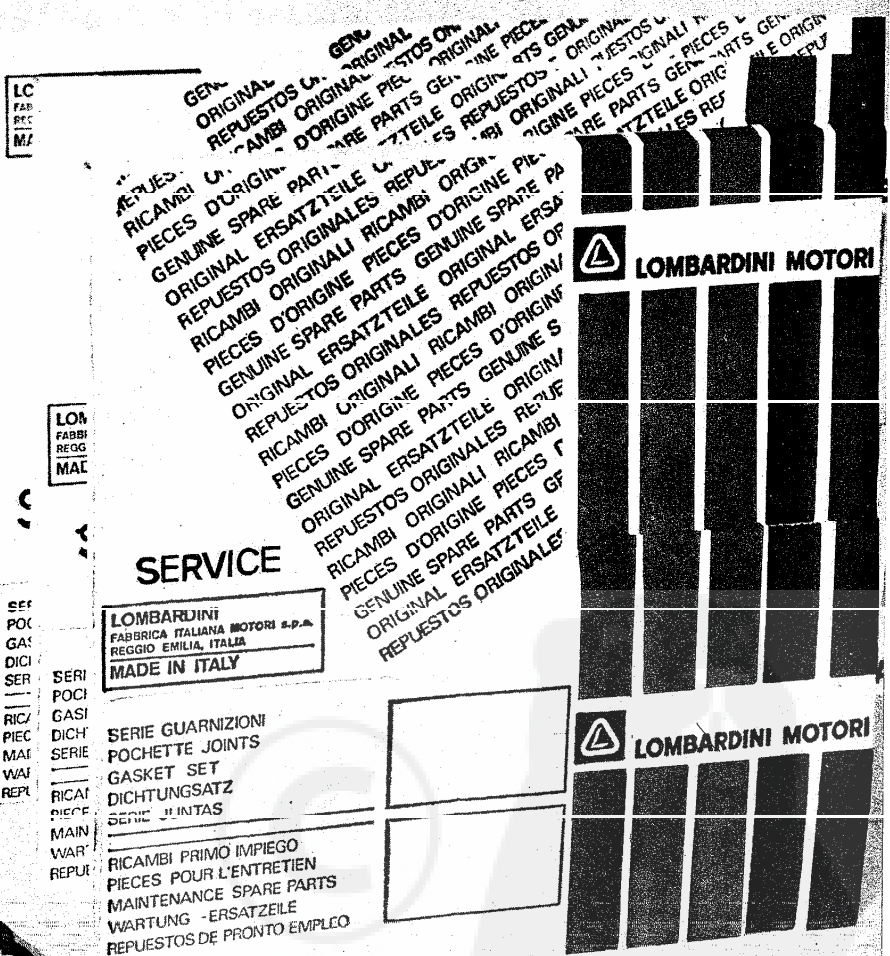

SERVICE

Per assistenza, ricambi, vendita di pezzi, riparazioni, rivolgersi alle stazioni di servizio autorizzate Lombardini. N. tel. su libretto
 Pour toute demande de renseignements, vente et pièces détachées, s'adresser aux stations de service autorisées Lombardini.
 Nach dem Kauf der Maschine wenden Sie sich an die autorisierten Lombardini-Service-Center. Telefonnummern sind im
 guida dell'utente riportate.
 Para asistencia, repuestos, venta de piezas y reparaciones, dirigirse a las estaciones de servicio autorizadas Lombardini. N. tel. en el libretto

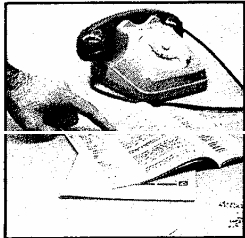
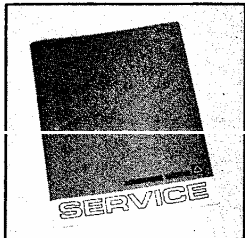

**ORDINI RICAMBI
 COMMANDES PIÈCES
 PART ORDERS
 E-TEIL BESTELLUNGS
 PEDIDOS DE REPUESTO**

**TIPO MOTORE
 TYPE DE MOTEUR
 ENGINE TYPE
 MOTORTYP
 TIPO DEL MOTOR**

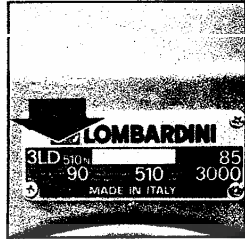
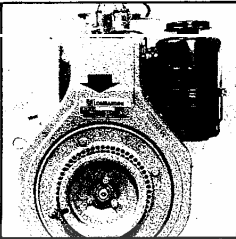

**MATRICOLA
 MATRICULE
 SERIAL NUMBER
 MOTORENNUMMER
 NUMERO DEL MOTOR**

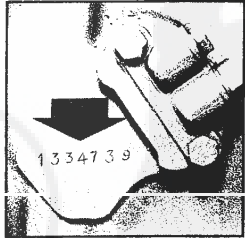
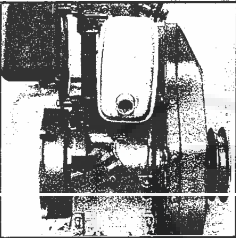
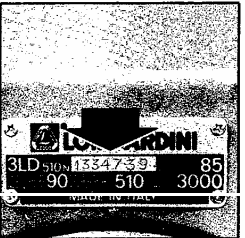
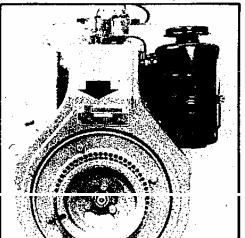

**TIPO DELLA MACCHINA
 TYPE DE MACHINE
 EQUIPMENT TYPE
 MASCHINENTYP
 MODELO DE LA MAQUINA**

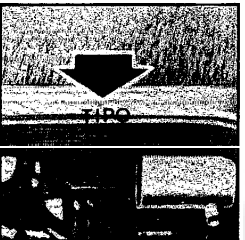
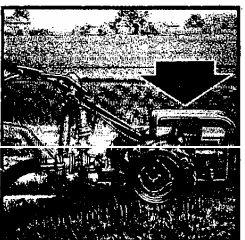

**MATRICOLA del ricambio
 REFERENCE de la pièce
 SPARE PART number
 BESTELLNUMMER des Teiles
 REFERENCIA del repuesto**

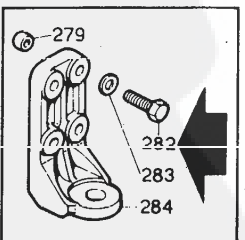
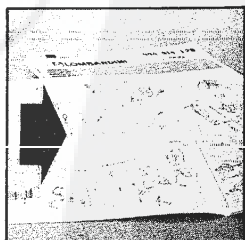

LOMBARDINI ENGINE
 LOMBARDINI FRANCE
 LOMBARDINI MOTOR
 LOMBARDINI MOTORS

**RICAMBI PER MOTORE STANDARD.
PER APPLICAZIONI SPECIALI CONSULTARE
IL CATALOGO PRESSO I CENTRI ASSISTENZA
E RICAMBI.**

**PIECES POUR DES MOTEURS STANDARD.
POUR LES ADAPTATIONS CONSULTER
LE CATALOGUE AUPRES
DES AGENTS SERVICE.**

**SPARE PARTS FOR STAND
FOR SPECIAL APPLICATION
CATALOG AT SERVICE CEN**

284-2942-65

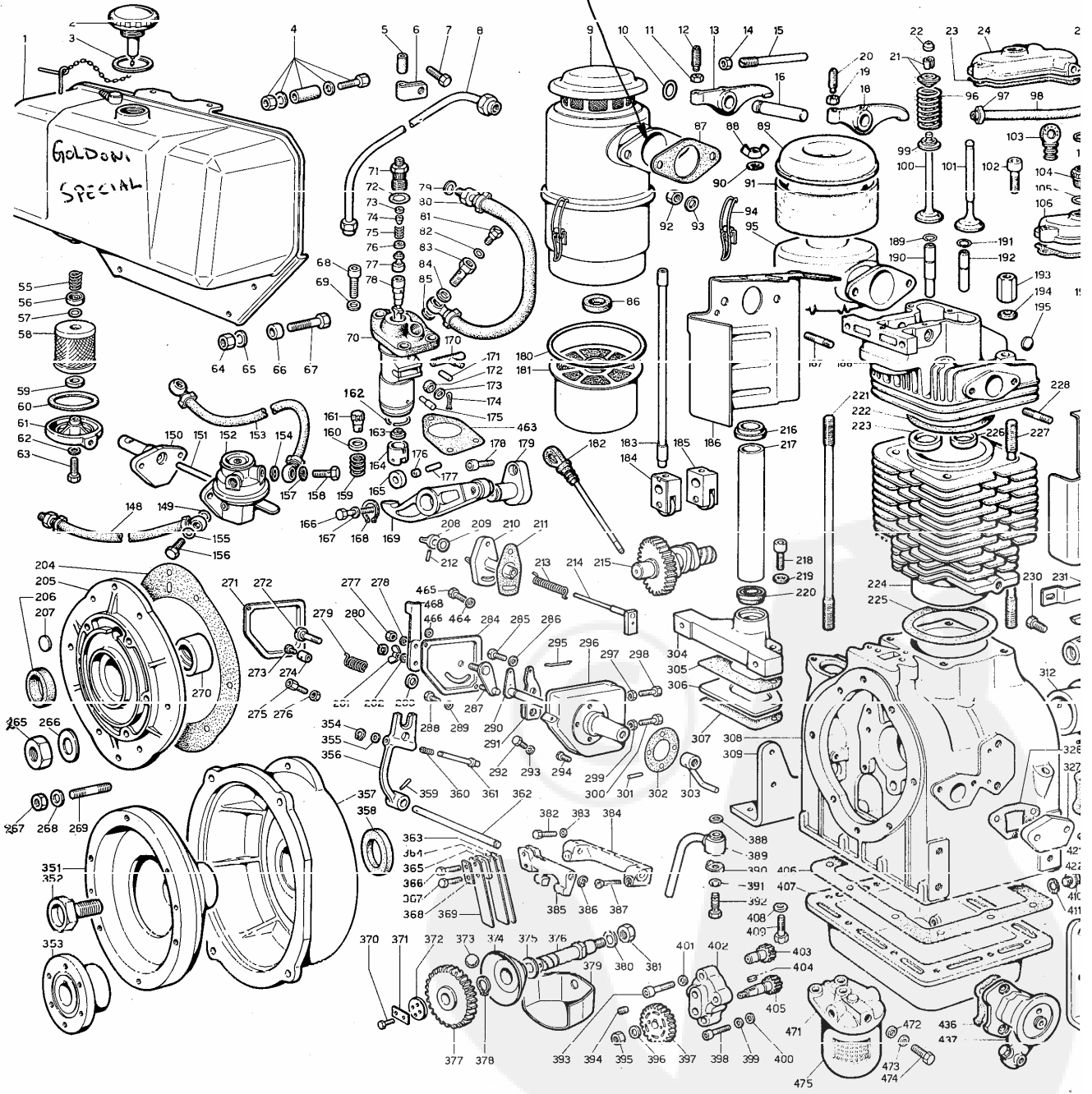

STANDARD ENGINE.
PARTS SEE MASTER
CENTERS.

ERSATZTEILE FÜR STANDARD-MOTOREN.
FÜR SONDERANFERTIGUNGEN SIEHE
ERSATZTEILKATALOG BEI SERVICE
WERKSTÄTTEN.

REPUESTOS PARA MOTORES STANDARD.
PARA APLICACIONES VEASE CATALOGO
EN LAS ESTACIONES SERVICE.

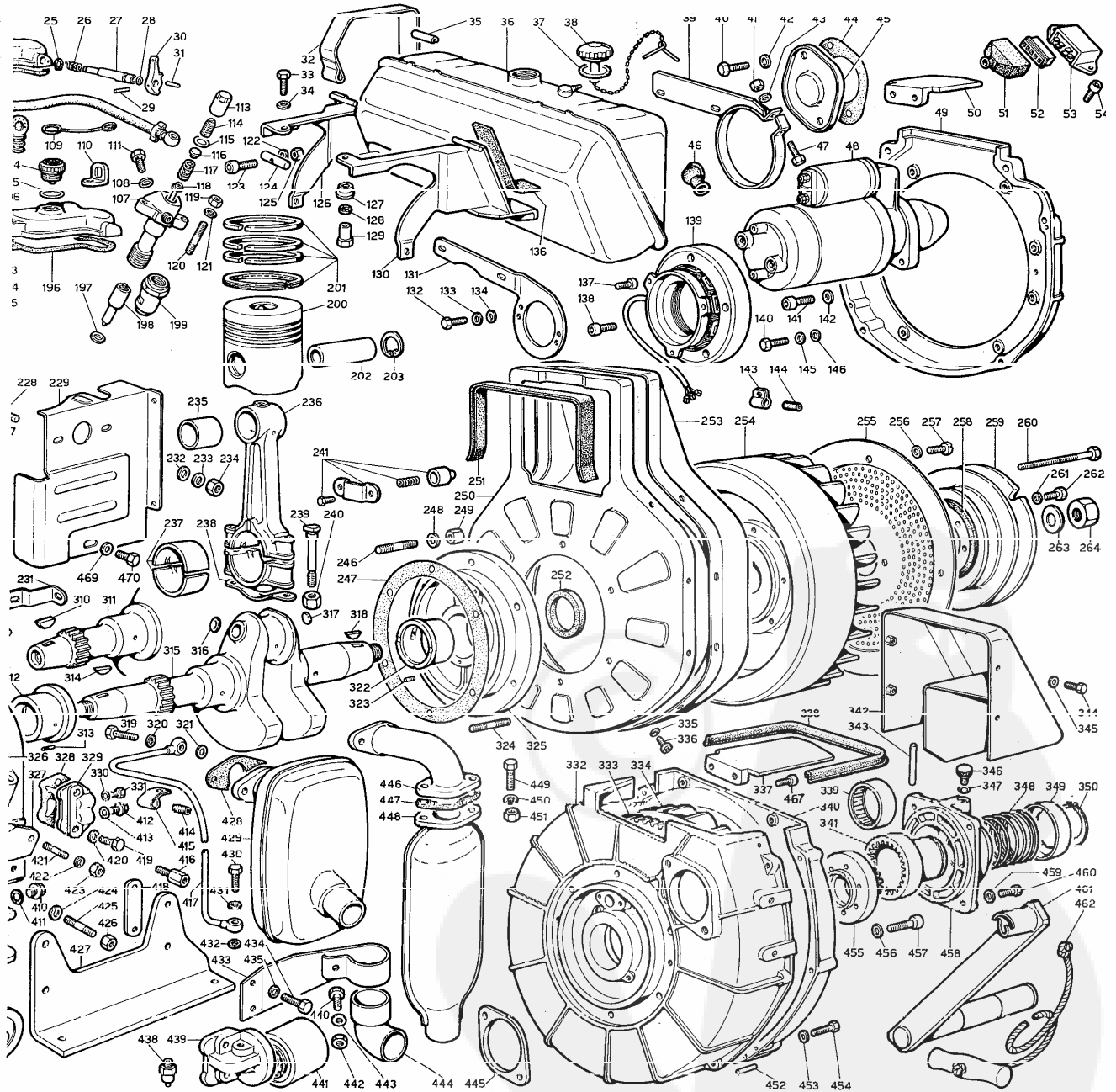



Gr. 3

3

LDA 75 ET 80
LDA 450
LDA 451
LDA 451 sin
LDA 510
L 8

3 LD 450
3 LD 450*
3 LD 450/S*
3 LD 510
3 LD 510/L

LEGENDA TAVOLA RICAMBI MATR.
SPARE PARTS TABLE P.NO. ... 1.5302.064
TABLEAU PIECES DETACHEES REF.

21.11.1986

MOTORI TIPO/ENGINES TYPE/MOTEURS TYPE

3LD 450 3LD 510 3LD 510/L
3LD 450/S 3LD 510/S

Vedi/see/voir

Libretto Uso e Manutenzione
Use-Maintenance booklet 1.5302.074
Livret Emploi-Entretien
Libretto Service
Service directory 1.7968.002
Reseau S.A.V.
Serie accessori
Accessory set 283.8140.080
Jeu accessoires

Note/Remarks/Remarques

- F - alta movimentazione/fast moving part/haut mouvement.
- S - media movimentazione/medium moving part/moyen mouvement.
- D - bassa movimentazione/slow moving part/bas mouvement.
- E - ad esaurimento/exhausting part/piece en epuiseement.
- N - particolare nuovo o fornito su richiesta/
new part or part supplied upon request/
piece nouvelle ou fournie sur demande.
- A - valido dal motore.../from eng.S.No.../a partir du moteur...
(vedi Circolare Tecnica/see Service Letter/voir Circ.Techn.)
- B - valido fino al motore.../up to eng.S.No.../jusqu'au moteur...
(vedi Circolare Tecnica/see Service Letter/voir Circ.Techn.)
- I - intercambiabile/interchangeable.
(vedi Circolare Tecnica/see Service Letter/voir Circ.Techn.)
- V - stock vitale per Officine Service.
vital stock for Service Dealer.
stock vital pour Stations Service.
- C - stock vitale per Costruttori,Esportatori,Enti di Stato.
vital stock for Producers,Exporters,State Companies.
stock vital pour Constructeurs,Export.,Institut.de L'Etat.
- R - stock vitale per Rettifica.
vital stock for Grinding Workshops.
stock vital pour Usines de Rectification.
- 10/50/2-q.ta minima fornibile/min.supplied q.ty/q.te min.fournie.
- = gruppo completo/assembly/groupe complet.
- + componente del gruppo/assembly component/composant du groupe.

Serie guarnizioni/Gasket set 283.8180.033

Blocco motore	Tipo motore
Short block	Engine type
2830.1560.014	3LD450 Industr.
2830.1560.013	3LD450 Automot.
2830.1560.187	3LD450 MTF-Meterbinder
2890.1560.070	3LD450/S
2920.1560.032	3LD510 Industr.
2920.1560.021	3LD510 Automot.

FIG. NO.	MATRICOLA PART NO.	Q.TA Q.TY	NOTE REMARKS	GR. 3 PAG.02
1+2+3=			SERB.LATO DISTRIB./GEAR SIDE F.TANK	
	=283.8103.055 F AC	1	std.	
✓	=2830.8103.007 F C	1	capacita'/capacity 1.7,5	
2+3=			TAPPO SERB./TANK CAP	
	=285.9043.037 FV C	1	std.	
	=2830.9043.025 FV C	1	per serbatoio/for fuel tank 1.7,5	
3+	9.1200.015 FV C 10	1	anello OR/rubber oil seal	
4	2830.9135.012 F C 10	2	tassello/cushion	
5	260.5390.006 D 10	1	manicotto/rubber sheating	
6	2830.3617.016 S C 10	1	fascetta/strip fixing	
7	9.1770.042 D C 10	1	bullone/bolt M 8 X 1,25 X 10	
8	271.9370.010 F C	1	tubo/fuel pipe	
9+86+94+180+181+568=			FILTRO ARIA/AIR CLEANER	
	=271.3700.014 FV C	1	per/for 3LD450-450/S	Diam.=105
9+86+94+180+181+513+568=			FILTRO ARIA CON CAPPELLOTTO AIR CLEANER WITH INLET CAP	
	=292.3700.101 FVIC	1	per/for 3LD450-450/S-510-510/S	diam.=140
	=2920.3700.128 DVIC	1	per/for 3LD510/L	diam.=120
10+	9.1200.026 FV C 10	1	anello OR/rubber oil seal	
11+	9.3240.010 S C 10	1	dado/nut	
12+	270.9850.002 F C 10	1	vite/screw	
13+10+11+12+14+15+16+18+19+20=			GRUPPO BILANC.COMPLETO ROCKER ARM ASS.Y	
	=283.4330.021 F C	1	per/for 3LD450-450/S-510-510/S	
	=288.4330.034 D	1	per/for 3LD510/L	
14+	9.3240.008 FV 10	1	dado/nut	
15+	283.9820.075 D C 10	1	vite/screw	
16+	283.6045.025 FV C 10	1	perno/rock.shaft 3LD450-450/S-510-510/S	
"	288.6045.027 S C	1	" " 3LD510/L	
18+		vedi/see fig.No. 13+...	
19+	9.3240.010 S C 10	1	dado/nut	
20+	270.9850.002 F C 10	1	vite/screw	
21+	271.6410.017 F C 10	2	piattello/retainer with half-collets	
22+	285.2135.068 FV C 10	1	cappello/cap	
23+	283.4400.012 FV C 50	1	guarnizione/joint 0,50	
"	283.4400.013 FV C 50	1	" " 0,20	
"	283.4400.014 FV C 50	1	" " 0,30	
24+25+26+27+28+29+30+31+102+110=			CAPPELLO BILANC.CON DECOMPRESSIONE ROCKER BOX CAP WITH DECOMPRESSION	
	=203.2125.099 F IC	1		
25+	9.1165.004 FV C 10	1	anello/circlip	
26+	270.5680.024 FV C 10	1	molla/spring	
27+	283.1110.053 F C	1	albero/shaft	

FIG. NO.	MATRICOLA PART NO.	Q.TA Q.TY	NOTE REMARKS	GR. 3 PAG.03
28+	9.1200.034 FV C 10	1	anello OR/rubber oil seal	
29+	9.8430.023 S C 10	1	spina/locating pin	
30+	500.5270.078 F C	1	leva/lever	
31+	9.8430.023 S C 10	1	spina/locating pin	
32+122+123+124+125= =2830.3617.039 F AC		2	FASCETTA FISSAGGIO SERBATOIO FUEL TANK FIXING CLAMP	
33	9.1760.003 D 10	2	bullone/bolt M 10 X 1,5 X 18	
34	9.7565.011 F C 10	2	rondella/washer	
35	271.9600.057 FV C 10	2	tubetto/rubber sheat	
36+37+38= =273.8101.021 F C		1	SERBATOIO COMPLETO LATO VOLANO FLYWHELL SIDE FUEL TANK	
37+	9.1200.015 FV C 10	1	anello OR/rubber oil seal	
38+37= =285.9043.037 FV C		1	TAPPO SERBATOIO FUEL TANK CAP	
39	2830.8546.033 S AC	1	staffa mot.avv./brace for st.eng.Bosch	
"	2830.8546.034 D AC	1	" per/for 3LD450/S-510/S	
40	9.1790.025 F C 10	2	bullone/bolt M 12 X 1,25 X 30	
41	9.3240.018 FV 10	1	dado/nut	
42	9.7565.013 S C 10	2	rondella/washer	
43	9.7565.007 F C 10	1	rondella/washer	
44	422.4775.042 N 50	1	guarnizione/joint	
45	270.6685.045 S	1	portina/cover	
46	2830.6491.005 FV C	1	pipetta/pipe elbow	
47	9.1770.009 D C 10	1	bullone/bolt M 8 X 1,25 X 35	
48	292.5840.065 F	1	mot.avv./st.eng. Bosch 3LD450-510-510/L	
"	287.5840.069 F C	1	mot.avv./st.eng. Bosch 3LD450/S-510/S	
51	276.2145.014 FVAC 10	1	cappuccio/rubber cap	
52	276.6740.088 FVAC 10	1	presa/inlet reg.Saprisa	
"	276.6740.089 SVAC 10	1	presa/inlet reg.Ducati	
"	276.6740.090 SVAC 10	1	" per/for reg.Ducati-spia c.b./c.b.light	
"	2830.6740.114 N 10	1	" per alt.luce/for light.altern.12V-120W	
53	2760.7362.027 FVIC	1	regolat.tensione/voltage reg.12 V-12 A	
"	9040.7362.066 FVIC	1	" 12 V-12 A spia c.b./c.b.light	
"	2830.7362.079 FV C	1	" per alt.luce/for light.altern.12V-120W	
54	9.9731.092 S 10	2	vite/screw M 8 X 1,25 X 14	
55+	273.5575.006 FV C 10	1	molla/spring	
56+	273.3930.019 F C 10	1	fondello/cup	
57+	9.1200.032 FV C 10	1	anello OR/rubber oil seal	
58+55+56+57+59+60+61+ 62+63= =273.3730.015 FV C		1	FILTRO COMBUSTIBILE COMPLETO FUEL FILTER ASS.Y	
58+	273.2175.009 FV C	1	cartuccia comb./f.filter element	
59+	273.4490.017 FV C 10	1	guarnizione/joint	
60+	260.4430.071 FV C 10	1	guarnizione/joint	
61+	273.2605.033 F AC	1	coperchio/filter cover	
62+	9.1202.052 FVAC 10	1	anello OR/rubber oil seal	
63+	9.1760.076 N A	1	bullone/bolt	
64	9.3240.010 FV 10	2	dado/nut	
65	9.7565.007 F C 10	2	rondella/washer std.	
"	9.7625.012 FV C 10	2	rondella serb./f.tank washer L.7,5	
66	273.3525.092 F C 10	2	distanziale/spacer	
67	9.1770.014 D C 10	2	bullone/bolt std. - M 8 X 1,25 X 45	
"	9.1770.007 F C 10	2	per/for serb./f.tank L.7,5 - M 8X1,25X30	

FIG. NO.	MATRICOLA PART NO.	Q.TA Q.TY	NOTE REMARKS	GR. 3 PAG. 04
68	9.9730.100 F	10 3	vite/screw M 8 X 1,25 X 25	
69	9.7625.010 FV C	10 3	rondella/washer	
	70+71+72+73+74+75+76+ 77+78+159+160+161+162+ 163+164+165+170+171+ 175+176+177=		POMPA INIEZIONE COMPLETA INJECTION PUMP	
	=283.6590.033 F C	1	std.	
	=283.6590.041 F C	1	Bosch type	
71+	271.7265.008 FV C	10 1	raccordo/connection	
72+	9.1200.031 FV C	10 1	anello OR/rubber oil seal	
73+	271.8335.029 SV C	10 1	spessore/shim	
74+	271.7470.003 FV C	10 1	riempitore/filler	
75+	271.5755.034 SV C	10 1	molla/spring	
76+	271.4760.015 FV C	10 1	guarnizione/joint	
77+	273.9672.013 F C	1	valvolina mandata/delivery valve std.	
	" 273.9672.014 S C	1	" " Bosch	
78+	283.6578.013 FV C	1	pompante/injection plunger std.	
	" 283.6578.020 FV C	1	" " Bosch	
79	9.4670.060 FVIC	10 1	guarnizione/copper joint	
80	7150.9375.116 E	1	tubo da serb.l.vol.a pompa iniez. mm 370 pipe from flywh.side f.tank to inj.pump	
	" 2830.9375.290 FVAC	1	" " mm 355	
	" 2830.9371.071 E	1	tubo da serb.l.dist.a pompa iniez. mm 273 pipe from gear side f.tank to inj.pump	
	" 273.9375.274 FVAC	1	" " mm 253	
81	9.9080.037 FV C	10 1	tappo/deaeration plug	
82	9.4775.196 SV C	10 1	guarnizione/joint	
83	9.1901.031 FVIC	10 1	bullone raccordo/connection bolt	
84	9.4670.060 FVIC	10 1	guarnizione/copper joint	
85	9.4670.060 FVIC	10 1	guarnizione/copper joint	
86+	271.3525.095 S C	1	per/for 3LD450-450/S diam.= 47	
	" 270.3525.080 F BC	1	" 3LD450-450/S 510-510/S " = 61	
	" 292.1261.073 DVAC	1	" " " = 62,5	
	" 500.1261.072 SVIC	1	" 3LD510/L " = 54	
87+	271.4500.067 FV C	10 2	guarnizione/joint	
88+	9.3200.002 FV C	10 1	dado/nut	
89+	291.2125.056 F C	1	per/for 3LD450-450/S-510-510/S diam.=139	
	" 500.2125.055 F C	1	" 3LD510/L diam.=121	
90+	9.7625.092 D C	10 1	rondella/washer	
91+	2910.1301.069 FV C	10 1	per/tor 3LD450-450/S-510-510/S diam.=138	
	" 500.1301.053 FV C	10 1	" 3LD510/L diam.=120	
92	9.3240.021 SV C	10 2	dado/nut	
93	9.7555.007 DV C	10 2	rondella/washer	
94+	276.4115.048 F C	10 2	gancio/hook	
	95+86+88+89+90+91+ 94+180+181+513+568=		FILTRO ARIA CON PREFILTRO CYCLONIC TYPE AIR CLEANER	
	=292.3700.102 FVIC	1	per/for 3LD450-450/S-510-510/S diam.=140	
	=2920.3700.129 N I	1	" 3LD510/L diam.=120	
96+	271.5755.005 FV C	10 2	molla/spring	
97	9.3630.050 F C	10 1	fascetta/clamp	
98	273.9570.080 FV C	10 1	tubo spurgo per serbatoio l.distrib. gear side f.tank bleeding pipe	
	" 2830.9571.046 FVIC	10 1	per serb.l.vol./for flywhell side f.tank	
99+	285.6410.038 F C	10 2	piattello/retainer	
100+	283.9652.017 FV CR10	1	valvola aspirazione/inlet valve	
101+	283.9685.027 FV CR10	1	valvola scarico/exhaust valve	
102+	9.9732.063 S AC	10 2	vite/screw M 8 X 1,25 X 35	

FIG. NO.	MATRICOLA PART NO.	Q.TA Q.TY	NOTE REMARKS	GR. 3 PAG.05
103	270.9055.003 FV C	10 1	tappo starter/cap	
104+105= =270.9050.021	FV C	1	TAPPO SFIATO/BREATHER CAP std.	
104+105+486+487+488= =2830.9050.029	FV C	1	TAPPO SFIATO PROTETTO BREATHER CAP PROTECTED	
105+	9.1200.014 FVIC	10 1	anello OR/rubber oil seal	
106+102+110= =283.2125.082	F IC	1	CAPPELLO BILANCIERI STD. ROCKER ARM COVER	
107+113+114+115+116+ 117+118+198+199= =292.6615.013 =292.6615.027	F C D C	1 1	INIETTORE COMPLETO NOZZLE HOLDER std. Bosch type	
107+	271.6615.002	D	1 portapolverizzatore/nozzle holder body	
108	9.4670.062	FVIC	10 2 guarnizione/copper joint	
109	500.3695.038	F C	10 1 filo/wire	
110+	904.8506.003	S AC	10 1 squadretta/angle bracket	
111	9.1901.033	FVIC	10 1 bullone raccordo/connection bolt	
113+	271.4130.058	SV C	10 1 ghiera/nut	
114+	271.1570.018	DV C	1 bocchettone/filler cap	
115+	271.4370.015	DV C	10 1 guarnizione/joint	
116+	271.8010.005	DV C	1 sede/seat	
117+	271.5800.065	SV C	1 molla/spring	
118+	271.1420.023	DVAC	1 asta comando/control rod	
119	9.3240.018	FV	10 2 dado/nut	
120+	9.6780.018	FV C	10 2 prigioniero/stud M 8 X 28 (43)	
121	9.7565.007	F C	10 2 rondella/washer	
122+	9.7625.062	D C	10 2 rondella/washer	
123+	9.9732.016	F C	10 2 vite/screw M 6 X 1 X 40	
124+	45.1557.019	F C	10 2 blocchetto/nut	
125+	9.3240.008	FV	10 2 dado/nut	
126	2830.5500.053	S IC	1 mensola/shelf	
127	2830.1185.036	S	2 anello/spacer	
128	2830.1257.020	D C	2 anello/ring	
129	2830.3206.043	FV C	10 2 dado/nut	
130	2830.5500.052	S IC	1 mensola/shelf	
131	2830.8546.032	S AC	1 staffa/brace	
132	9.1770.001	FV	10 2 bullone/bolt M 8 X 1,25 X 12	
133	9.7565.011	F C	10 2 rondella/washer	
134	9.7625.098	D C	10 2 rondella/washer	
136	2830.8315.027	S IC	10 2 spessore/shim	
137	9.9730.010	S	10 4 vite/screw M 6 X 1 X 16	
"	9.1760.005	FV	10 3 " per alt.luce/for light.alt.-M 6X1X16	
138	9.9730.015	F C	10 5 vite/screw M 6 X 1 X 30	
139	283.1156.090	FVIC	1 alternatore/volt.alternator 12V 12A	
140	9.1790.025	F C	10 5 bullone/bolt M 12 X 1,25 X 30	
141	9.9730.045	F	10 2 vite/screw M 10 X 1,5 X 30	
142	9.7565.011	F C	10 2 rondella/washer	
143	2790.3617.017	D	10 1 fascetta/strip fixing	
144	260.5390.006	D	10 1 manicotto/rubber sheating	
145	9.7565.013	S C	10 5 rondella/washer	
146	9.7625.026	S	10 5 rondella/washer	
148	2830.9373.006	E	1 tubo da serbatoio a pompa alimentaz.	
"	2830.9375.294	S AC	1 pipe from fuel tank to feed pump mm 307	
149	9.4670.059	FVIC	10 1 guarnizione/copper joint	
150	271.8901.080	S IC	1 supporto/support	

FIG. NO.	MATRICOLA PART NO.	Q.TA Q.TY	NOTE REMARKS	GR. 3 PAG.06
151	283.6495.023 S AC	1	pistoncino/plunger	
152	283.6585.031 FV C	1	pompa alim./feed pump	
153	2830.9373.005 S C	1	tubo da pompa aliment.a pompa iniez. pipe from feed pump to injection pump	
154	9.4670.059 FVIC 10	1	guarnizione/copper joint	
155	9.4670.059 FVIC 10	1	guarnizione/copper joint	
156	9.1901.030 FVIC 10	1	bullone raccordo/connection bolt	
157	9.4670.059 FVIC 10	1	guarnizione/copper joint	
158	9.1901.030 FVIC 10	1	bullone raccordo/connection bolt	
159+	260.5625.002 SV C	1	molla/spring	
160+	260.7980.020 SV C	1	scodellino/cup	
161+	260.4850.009 FV C	1	guida/guide	
162+	9.1260.084 DV C 10	1	anello/ring	
163+	260.6400.024 D	1	piattello/retainer	
164+	260.7215.017 FV C	1	punteria/tappet	
165+	260.7770.020 SV C	1	rullo/roller	
166	9.1770.015 F 10	1	bullone/bolt M 8 X 1,25 X 55	
167	9.7565.007 F C 10	1	rondella/washer	
168	9.1240.013 D 10	1	anello seeger/snap ring	
169	283.4330.025 F IC	1	bilanciere pompa iniez./inj.pump rocker	
170+	270.1415.007 DV C	1	asta/rod	
171+	277.6230.075 SV C 10	1	perno/pin	
172	270.1580.016 F C 10	1	boccola/bushing	
173	9.7626.017 D C 10	1	rondella/washer	
174	9.2800.003 F C 10	1	copiglia/cotter pin	
175+	260.6230.069 DV C	1	perno/pin	
176+	260.1970.054 DV C	1	bussola/sleeve	
177+	260.6230.068 SV C	1	perno/pin	
178	9.9732.092 F C 10	1	vite/screw M 8 X 1,25 X 18	
179	271.6045.009 F C	1	perno bil./rocker shaft 3LD450-510-510/L	
"	270.6110.049 D C	1	" " " 3LD450/S-510/S	
180+	9.1200.024 FV C 10	1	per/for 3LD450-450/S h=5,5 d.=111	
"	291.4776.032 FV C 10	1	" 450-450/S-510-510/S h=7 d.=154	
"	500.3526.052 F BC 10	1	" 3LD510/L h=16 d.=115	
"	500.4775.120 FVAC 10	1	" " h=10 d.=135	
181+	271.5496.013 FV C	1	" 3LD450-450/S h=62 d.=103	
"	292.5496.111 FVIC	1	" 450-450/S-510-510/S h=87 d.=138	
"	500.5496.057 FVBC	1	" 3LD510/L h=87 d.=120	
"	500.5496.071 SVAC	1	" " h=90 d.=119	
182	271.1400.018 F C 10	1	asta livello/dipstick std.	
"	2920.1400.073 F C 10	1	per filtro olio est./for ext.oil filter	
183	271.1410.012 FV C	2	asta punteria/push rod	
184	271.4887.003 SV C	1	punt.lato distrib./gear side tappet	
185	271.4887.004 SV C	1	punt.lato volano/flywheel side tappet	
186	283.5066.014 S AC	1	lamiera/airtight plate std.	
"	292.5066.086 N	1	lamiera inson./silenced plate std.	
"	283.5066.016 S A	1	per avviamento elettrico o manovella for electric/handle starting	
"	292.5066.094 N	1	insonorizzata per avv.elett. o manovella silenced for electric/handle starting	
187+	9.6780.010 DV C 10	2	prigioniero/stud std. M 8 X 22 (34)	
"	9.6780.052 D C 10	2	per com.stop e suppl.a dist.-M8X18(28) for remote stop and suppl.control	
188+10+11+12+13+14+15+			TESTA COMPLETA	
16+18+19+20+21+22+96+			CYLINDER HEAD	
99+100+101+120+187+189+				
190+191+192+195+223+226+				
228=	=283.9200.087 F C	1		

FIG. NO.	MATRICOLA PART NO.	Q.TA Q.TY	NOTE REMARKS	GR. 3 PAG.07
188+99+120+187+189+190+ 191+192+223+226+228= =283.9200.088 F C		1	TESTA CON SEDI E GUIDE CYLINDER HEAD WITH SEATS AND GUIDES	
189+	285.1160.014 FV C 10	1	anello/circlip	
190+	285.4845.053 FV CR10	1	guida v.aspir./inlet v.guide std.	
"	285.4845.058 FV CR10	1	" " " " +0,50	
191+	285.1160.014 FV C 10	1	anello/circlip	
192+	285.4845.050 FV CR10	1	guida v.scarico/exhaust v.guide std.	
"	285.4845.059 FV CR10	1	" " " " +0,50	
193	273.3206.013 FV C 10	4	dado/nut	
194	9.7625.022 S 10	4	rondella/washer	
195+	9.8990.017 F C 10	1	tappo/plug	
196	283.4400.012 FV C 50	1	guarnizione/joint 0,50	
"	283.4400.013 FV C 50	1	" " " 0,20	
"	283.4400.014 FV C 50	1	" " " 0,30	
197	9.4670.005 FV C 10	1	guarnizione/copper joint 0,50	
"	9.4670.006 FV C 10	1	" " " 1,00	
198+	710.6531.033 FVIC	1	polverizzatore/nozzle	
199+	271.4130.060 SV C	1	ghiera/ring nut	
200+201+202+203= =283.6501.044 FV C =283.6501.045 F CR =283.6501.046 F CR =292.6501.073 FV C =292.6501.074 F CR =292.6501.075 F CR		1 1 1 1 1 1	PISTONE COMPLETO/PISTON SET std. per/for 3LD450-450/S +0,50 +1,00 std. per/for 3LD510-510/S-510/L +0,50 +1,00	
201+	283.8210.055 FV C 10	1	std. per/for 450-450/S-510-510/S-510/L	
"	283.8210.056 F CR10	1	+0,50 " " (4 segmenti/rings)	
"	283.8210.057 F CR10	1	+1,00 " " " "	
"	283.8211.009 FVAC 10	1	std. per/for 3LD450-450/S	
"	283.8211.010 F ACR10	1	+0,50 " " (3 segmenti/rings)	
"	283.8211.011 F CR10	1	+1,00 " " " "	
202+	271.8480.009 S C	1	spinotto/gudgeon pin	
203+	9.1240.019 FV C 10	2	anello seeger/snap ring	
204+	271.4600.001 FV C 50	1	guarnizione/joint 0,30	
"	283.4601.030 N 50	1	" " " 0,10	
205+207= =271.6646.092 F C		1	PORTINA LATO DISTR./CASE COVER industriale/industrial version	
206	9.1213.060 FVIC 10	1	anello ten./seal ring 3LD450-510-510/L	
"	9.1213.014 SV C 10	1	anello ten./seal ring 3LD450/S-510/S	
207+	9.8990.008 S 10	1	tappo/plug	
208+		vedi/see fig.No. 214+...	
209+	9.1200.041 FV 10	1	anello OR/rubber oil seal	
210+		vedi/see fig.No. 214+...	
211+	270.4700.070 N 50	1-3	guarnizione/joint 0,50	
212+	9.8420.001 D C 10	1	spina/locking needle	
213+	270.5550.007 JV C 10	1	molla/spring	
214+208+209+210+212+ 213= =272.2516.045 F IC		1	COMANDO SUPPLEMENTO DEVICE CONTROL	
215	291.1010.060 F C	1	albero camme/camshaft 3LD450-510-510/L	
"	293.1010.070 F C	1	albero camme/camshaft 3LD450/S-510/S	
216	292.4740.017 FV C 10	1	guarnizione/joint	
217	273.9520.039 FV C	1	tubo protez./guard tube	

FIG. NO.	MATRICOLA PART NO.	Q.TA Q.TY	NOTE REMARKS	GR. 3 PAG.08
218	9.9730.100	F 10	2 vite/screw M 8 X 1,25 X 25	
219			
220	292.4740.017	FV C 10	1 guarnizione/joint	
221+	271.6850.025	FV C 2	2 prigion.lato distr./gear side stud	
222+	283.4730.117	FVAC 10	1 guarnizione testa/head joint 0,60	
"	283.4730.118	FVAC 10	1 " " 0,70	
"	283.4730.119	FVAC 10	1 " " 0,80	
"	283.4730.120	FVAC 10	1 " " 0,90	
"	283.4730.121	FVAC 10	1 " " 1,00	
223+	292.9000.034	FV CR10	1 sede v.aspirazione/inlet v.seat	
224	283.2380.074	FV C 1	1 cilindro/cylinder 3LD450-450/S	
"	292.2380.083	FV C 1	1 cilindro/cylinder 3LD510-510/S-510/L	
225+	283.4410.064	FVAC 10	1 guarnizione/joint	
226+	283.8000.037	FV CR10	1 sede v.scarico/exhaust v.seat	
227+	271.6850.041	FV C 2	2 prig.lato volano/flywheel side stud	
228+	9.6780.069	F 10	2 prigioniero/stud M 8 X 25 (37)	
229	283.5066.013	S AC 1	1 lamiera/airtight plate std.	
"	292.5066.007	N 1	1 lamiera inson./silenced plate std.	
"	283.5066.015	S A 1	1 per avviamento elettrico o manovella for electric/handle starting	
"	292.5066.095	N 1	1 insonorizzata per avv.elett. o manovella silenced for electric/handle starting	
230	9.1760.001	FV 10	2 bullone/bolt M 6 X 1 X 10	
231	283.8490.083	S C 2	2 squadretta/bracket	
232	9.7625.061	D C 10	2 rondella/washer	
233	9.7565.097	F C 10	2 rondella/washer	
234	9.3240.019	FV C 10	2 dado/nut	
235+	271.1630.007	FV CR 1	1 bronz.piede biella/small end bearing	
236+235+239+240=	=271.1526.003	F IC 1	BIELLA COMPLETA CONNECTING ROD ASS.Y	
237	271.1640.027	FV C 1	1 bronz.biella/large end bushing std.	
"	271.1640.028	F CR 1	1 " " -0,25	
"	271.1640.029	F CR 1	1 " " -0,50	
238	271.6330.012	E 10	1 piastrina/safety plate	
239+	271.1860.008	FV C 10	2 bullone/bolt	
240+	9.3203.035	FVIC 10	2 dado/nut	
241	273.9680.010	SVBC 1	1 valvolina pressione/pressure oil valve	
"	292.9680.015	FVBC 1	1 " " " "	
"	292.9680.016	FVAC 1	1 " " " "	
246+	9.6780.009	D 10	1 prigioniero/stud m 8 x 21 (31)	
247+	271.4700.009	FV C 50	1 guarnizione/joint 0,30	
"	283.4700.077	SV C 10	1 " " 0,10	
248			
249	9.3203.047	FV C 10	6 dado/nut	
250	283.6372.055	F AC 1	1 piastra/plate std.	
"	292.6370.181	N 1	1 piastra insonorizzata/silenced plate	
251	283.4570.013	SV C 10	1 guarnizione/joint	
252	9.1210.076	FV C 10	1 anello t./seal ring 3LD450-510-510/L	
"	9.1210.084	FV C 10	1 " " " " -1,00	
"	9.1213.006	FVIC 10	1 " " " " 3LD450/S-510/S	
253	283.2568.068	F AC 1	1 conv./shroud 3LD450-510-510/L std.	
"	292.2569.173	N 1	1 " " " " inson./sil.	
"	283.2568.075	F AC 1	1 " " " " 3LD450/S-510/S std.	
"	292.2569.174	N 1	1 " " " " inson./sil.	
"	2830.2569.016	N 1	1 version Pasquali MTC 917-935	
"	2830.2569.017	N 1	1 version Pasquali MTC 937	
"	2830.2568.089	S A 1	1 altre versioni/other D.E.M.versions	
254	292.9882.040	S IC 1	1 volano/flywheel 3LD450-510-510/L	
"	287.9885.045	D AC 1	1 " " " " 3LD450/S-510/S	

FIG. NO.	MATRICOLA PART NO.	Q.TA Q.TY	NOTE REMARKS	GR. 3 PAG.09
255	283.5096.019	F AC	1 lamiera protez./guard panel	
256	9.7540.006	D C 10	4 rondella/washer	
257	9.9810.012	S	4 vite/screw	
258	283.1301.096	D AC 10	1 anello/spacer	
259	283.6961.029	FVAC	1 puleggia/pulley std. 3LD450-510-510/L	
"	292.6961.048	FVIC	1 puleggia 2 gole/2 grooves pulley	
"	2830.6961.030	SVAC	1 puleggia/pulley std. 3LD450/S-510/S	
"	2830.6961.049	N	1 " min.ingomb./dimension	
"	283.6961.043	N	1 per avv.manov./for handle starting	
261	9.7545.007	F C 10	3 rondella/washer	
262	9.1770.085	FV C 10	3 bullone/bolt std. M 8 X 1,25 X 45	
"	9.1770.007	F C 10	3 bullone/bolt M 8 X 1,25 X 30	
"	9.1770.017	D	3 bullone/bolt M 8 X 1,25 X 60	
"	9.1770.021	N	3 per pul.avv.manovella - M 8X1,25X85 for handle starting pulley	
263	9.7625.037	D C 10	1 rondella/washer	
264	9.3260.056	FV C 10	1 dado/nut 3LD450-510-510/L	
"	9.3260.027	FV C 10	1 " " 3LD450/S-510/S	
265	9.3260.014	S	1 dado/nut 3LD450-510-510/L	
"	9.3260.011	SV C 10	1 " " 3LD450/S-510/S	
266	9.5715.062	N	1 molla/spring washer	
267	9.3203.047	FV C 10	8 dado/nut	
268			
269+	9.6780.075	DV C 10	8 prigioniero/stud M 8 X 21 (35)	
270	271.1710.042	FV C	1 bronz./bearing std. 3LD450-510-510/L	
"	271.1710.047	F ICR	1 " " 1,00	
"	273.1710.047	FV C	1 bronz./bearing std. 3LD450/S-510/S	
271+273+274+275+276+			COMANDO A DISTANZA	
279+285+286+288+290+			REMOTE CONTROL	
291+295+296+297+298+				
299+300+301+303+476=				
=273.2515.027			F IC 1 std.	
271+	270.2690.042	F C 10	1 coperchio/cover	
273+	9.9790.003	F C 10	1 vite/screw M 4 X 0,7 X 6	
274+	45.6000.016	FV C 10	1 pastiglia/nut	
275+	2760.9180.042	S C 10	1 terminale/end	
276+	9.3240.019	FV C 10	1 dado/nut	
277+	9.3240.004	FV C 10	1 dado/nut	
278+	90.6330.057	F C 10	1 piastrina/safety plate	
279+	270.5080.025	SV C 10	1 molla/spring	
280+	9.1165.001	S	1 anello/circlip	
281+	9.3200.015	FVIC	1 dado/nut	
282+	9.7626.054	S AC 10	1 rondella/washer	
283+	9.7626.054	S AC 10	1 rondella/washer	
284+277+278+279+280+			COMANDO A MANO	
281+282+283+285+286+			HAND CONTROL	
287+288+290+291+292+				
293+295+296+297+298+				
299+300+301+303+466+				
468+476=				
=273.2515.029			F C 1 std.	
284+	283.2690.122	F AC 10	1 coperchio/cover	
285+	270.9820.073	D BC 10	1 vite/screw	
"	272.9820.109	D AC 10	1 " "	
286+	9.7625.007	S C 10	1 rondella/washer	
287+	283.6370.114	S AC 10	1 piastra/plate	
288+	9.9790.037	FV C 10	2 vite/screw M 6 X 1 X 8	

FIG. NO.	MATRICOLA PART NO.	Q.TA Q.TY	NOTE REMARKS	GR. 3 PAG.10
289			
290+		vedi/see fig.No. 303+...	
291+	270.5200.086	S BC 10	1	leva/lever
"	272.5200.254	D AC	1	"
292+	9.1770.042	D C 10	1	bullone/bolt M 8 X 1,25 X 10
293+	9.7555.007	DV C 10	1	rondella/washer
294	9.9800.061	F C 10	4	vite/screw M 6 X 1 X 16
295+	270.9245.031	S C 10	1	tirante/tie rod
296+	270.7865.018	D BC	1	scatola/housing std.
"	272.7865.088	D AC	1	"
297+	9.3240.008	FV 10	1	dado/nut
298+	9.1760.029	D A 10	1	bullone/bolt M 6 X 1 X 30
299+	9.3240.008	FV 10	1	dado/nut
300+	9.1760.029	D C 10	1	bullone/bolt M 6 X 1 X 30
301+	9.8420.012	D C 10	1	spina/taper pin
302+	270.4700.069	N 50	1	guarnizione/joint
303+290+301=	=283.5200.292	S C	1	LEVA/LEVER
304	273.4840.007	FV C	1	guida/guide
305+	273.4535.012	FV C 10	1	guarnizione/joint
306	273.5168.018	D C 10	1	lamierino/panel
307+	273.4535.012	FV C 10	1	guarnizione/joint
308+221+227+246+269+				BASAMENTO COMPLETO
313+324+326+327+328+				CRANKCASE
329+330+331+412+413+				
419+420+421+422+423=				
	=283.1511.089	F IC	1	per/for 3LD450-510-510/L
	=287.1511.091	F C	1	per/for 3LD450/S-510/S
309	283.6427.090	F C	1	piede/engine mount
310+	9.2280.049	FV 10	1	chiavetta/key
311+310+316+317+318=				ALBERO GOMITO/CRANKSHAFT mm 327
	=271.1050.040	F C	1	per/for 3LD450 autotrazione/automotive
	=275.1050.068	F C	1	" 3LD450/S
	=292.1051.013	F C	1	" 3LD510-510/L
	=2920.1050.350	S C	1	" 3LD510/S
	=295.1051.039	D C	1	" 3LD450 motoralciatrice/motorhinder
311+316+317+318=				ALBERO GOMITO/CRANKSHAFT mm 356
	=2830.1050.358	S C	1	per/for 3LD450 gr.elettr./generating sets
	=2920.1050.360	S C	1	" 3LD510
312	283.1610.066	FV C	1	bronz.lato distr./gear side bear. std
"	283.1610.067	F CR	1	" -1,00
313+	9.8430.055	S IC 10	1	spina/locating pin
314+	9.2280.046	S C 10	1	chiavetta/key
315+314+316+317+318=				ALBERO GOMITO/CRANKSHAFT mm 368
	=273.1050.062	F C	1	per/for 3LD450 industrial
	=273.1051.050	D C	1	" 3LD450/S
	=292.1051.005	F C	1	" 3LD510-510/L
316+	9.8990.006	F L 10	1	tappo/plug
317+	9.8990.002	F C 10	1	tappo/plug
318+	9.2280.056	FV C 10	1	chiavetta/key
319	9.9730.109	D C 10	1	vite/screw 3LD510/L M 6 X 1 X 16
320	9.4670.062	FVIC 10	1	guarnizione/copper joint

FIG. NO.	MATRICOLA PART NO.	Q.TA Q.TY	NOTE REMARKS	GR. 3 PAG.11
321	9.4670.062	FVIC 10	1 guarnizione/copper joint	
322	271.1610.023	FV C	1 bronz.lato volano/flywh.side bear. std.	
"	271.1610.024	F CR	1 " " " " " " " "	-1,00
323	9.8430.055	S IC 10	1 spina/locating pin	
324+	9.6780.075	S C 10	5 prigioniero/stud M 8 X 21 (35)	
325	292.8676.098	F AC	1 supporto alb.gom./crankshaft support	
326+	560.4580.047	FVIC 10	1 guarnizione/joint 1,00	
"	560.4580.049	FV C 10	1 " " " " " " " "	0,50
"	560.4580.050	FV C 10	1 " " " " " " " "	0,80
327+	255.6700.012	S C	1 portina/cover	
328+	270.4730.021	SV C 10	1 guarnizione/joint	
329+328+330+331+412+ 413+419+420= =270.3901.041	S C	1	FLANGIA FILTRO OLIO ESTERNO FLANGE FOR EXTERNAL OIL FILTER	
330+	9.4670.058	FV C 10	1 guarnizione/copper joint	
331+	9.1770.001	FV 10	1 bullone/bolt M 8 X 1,25 X 12	
332	292.8590.025	F A	1 supporto alb.gom./crankshaft support	
333	283.2816.038	F AC	1 corona avv./crown gear 3LD450-510-510/L	
"	287.2816.039	D AC	1 " " " " " " " "	3LD450/S-510/S
334	292.9882.040	S IC	1 volano avv.el./electr.start.flywhell su/on 3LD450-510-510/L	
"	287.9885.045	D AC	1 volano avv.el./electr.start.flywhell su/on 3LD450/S-510/S	
"	283.9885.061	N A	1 volano per avviam.manovella ed elettr. handle and electr.start.flywhell	
335			
336	9.9790.037	FV C 10	8 vite/screw M 6 X 1 X 8	
337	273.3350.062	S	1 per avv.elettrico/for electric starting	
"	283.3350.074	D A	1 per avv.manovella/for handle starting	
338	283.4570.014	S 10	1 per avv.elettrico/for electric starting	
"	283.4570.015	D A 10	1 per avv.manovella/for handle starting	
339	9.1585.058	S	2 boccola/bushing	
340	283.2568.067	F AC	1 per avv.elettr./for elect.start.	
"	292.2569.186	N	1 inson.per avv.el./silenced for el.start.	
"	283.2569.010	N A	1 per avv.manovella/for handle starting	
341	2830.4970.012	D B	1 ingranaggio/gearwheel	
"	283.4970.015	S A	1 " " " " " " " "	
342	283.2920.078	S A	1 cuffia avv.elettr./electric start.hood su/on 3LD450-510-510/L	
"	287.2920.082	N A	1 cuffia avv.elettr./electric start.hood su/on 3LD450/S-510/S	
"	283.2920.085	N A	1 cuffia avv.manov./handle start.hood	
343	9.8430.019	S 10	1 spina/locating pin	
344	9.1760.001	FV 10	4 bullone/bolt M 6 X 1 X 10	
345	271.7500.018	SV C 10	4 rondella/washer	
346	5000.8965.031	D	1 tappo/plug	
347	9.1202.016	FV C 10	1 anello OR/ruhber oil seal	
348	500.5801.027	S A	1 molla/spring	
349	500.7980.045	S A	1 scodellino/cup	
350	9.1240.041	S 10	1 anello seeger/snap ring	
351	273.2052.028	S	1 campana/flang.bell 3LD450-510-510/L	
"	2830.2051.048	F	1 campana/flang.bell 3LD450/S-510/S	
"	273.2051.003	F	1 campana motofalc./motormover bell 3LD450	
352	2910.1862.013	S	1 bullone/bolt 3LD450-510-510/L	
"	2710.1861.017	D C	1 bullone/bolt 3LD450/S-510/S	
"	291.1862.012	S C	1 bullone motofalc./motorbinder bolt 3LD450	
353	2830.5855.002	S	1 mozzo/hub	
354+	9.1165.001	S 10	1 anello/circlip	
355+	9.7625.074	N 10	1 rondella/washer	

FIG. NO.	MATRICOLA PART NO.	Q.TA Q.TY	NOTE REMARKS	GR. 3 PAG. 12
356+	283.5201.044 S C	1	leva/lever	
357+207=			CAMPANA/FLANG. BELL	
	=273.2032.008 S I	1	per/for 3LD450-510-510/L	
	=2830.2032.048 D	1	" 3LD450/S-510/S	
	=273.2032.009 D	1	" motofalciatrice/motorbinder 3LD450	
358	9.1213.058 FVIC 10	1	anello t./seal ring 3LD450-510-510/L	
"	9.1213.007 FVIC 10	1	" 3LD450/S-510/S	
359+	9.8420.012 D C 10	1	spina/locking needle	
360+	285.5800.088 D I	1	molla/spring	
361+	283.6231.038 D AC 10	1	perno/pin	
362+	270.6140.013 D C 10	1	perno/pin	
363+	270.5655.005 FV C 10	1	molla/spring	
364+	270.5655.005 FV C 10	1	molla/spring	
365+	270.1557.021 D C 10	1	blocchetto/retainer	
366+	9.1755.004 D C 10	1	bullone/bolt M 5 X 0,6 X 10	
367+	9.1755.002 D 10	1	bullone/bolt M 5 X 0,6 X 12	
368+	285.6330.061 D 10	1	piastrina/safety plate	
369+	270.5655.005 FV C 10	1	molla/spring	
370	9.1750.035 S C 10	2	bullone/bolt M 4 X 0,7 X 12	
371	270.6275.038 DV C 10	1	piastrina/plate	
372	270.6370.038 D C 10	1	piastrina/plate	
373	9.8245.011 F C 10	6	sfera/ball	
374	270.2085.029 F	1	campana regol./speed gov. bell	
375	270.7700.069 S C 10	1	rondella/washer	
376	271.6130.016 S C	1	perno/shaft	
377	270.4935.068 F C	1	ingranaggio/gear	
378	9.1240.006 FV C 10	1	anello seeger/snap ring	
379	273.6927.004 FV C	1	protezione/guard	
380	9.7625.019 S 10	1	rondella/washer	
381	9.3240.033 FV 10	1	dado/nut	
382	9.1760.012 D C 10	1	bullone/bolt M 6 X 1 X 35	
383	9.7540.004 D C 10	1	rondella/washer	
384+354+355+356+359+			GRUPPO FORCELLA REGOLATORE	
360+361+362+363+364+			SPEED GOVERNOR YOKE ASS.Y	
365+366+367+368+369+				
385+386+387=				
	=285.4882.007 S IC	1	std.	
384+	270.8615.020 D C	1	supporto/support	
385+	270.3945.027 S C	1	forcella/yoke	
386+	9.1165.006 D C 10	1	anello/circlip	
387+	9.9800.082 N 10	1	vite/screw M 6 X 1 X 35	
388	9.4670.036 FV C 10	1	guarnizione/copper joint	
389	283.7300.069 E B	1	raccordo/connection	
"	283.9320.082 S AC	1	tubo/pipe	
390	276.5111.008 D RC 10	1	lamierino/tabwasher	
"	283.5111.075 D AC 10	1	lamierino/tabwasher	
391	9.1200.034 SVBC 10	1	anello OR/rubber oil seal	
"	9.4670.036 D A 10	1	guarnizione/copper joint	
392	9.1901.046 D A 10	1	bullone raccordo/connection bolt	
393	9.9730.030 S C 10	2	vite/screw M 8 X 1,25 X 35	
394	9.9765.001 S C 10	1	vite/screw M 6 X 1 X 8	
395	9.3203.014 FV C 10	1	dado/nut	
396	9.7625.010 FV C 10	1	rondella/washer	
397	272.4975.018 F IC	1	ingranaggio/gearwheel	
398	9.9732.016 F C 10	1	vite/screw M 6 X 1 X 40	
399	9.7565.004 F C 10	1	rondella/washer	
400	9.7625.007 S C 10	1	rondella/washer	

FIG. NO.	MATRICOLA PART NO.	Q.TA Q.TY	NOTE REMARKS	GR. 3 PAG.13
401	9.7625.010	FV C 10	2	rondella/washer
402	272.4336.023	F IC	1	pompa olio/lub.oil pump 3LD450-510-510/L
"	287.4336.025	F IC	1	3LD450/S-510/S
404	9.2200.001	F C 10	1	chiavetta/key
406+	271.4600.090	D 10	1	guarnizione/joint
407+410+411= =283.6647.057 F IC			1	PORTINA DI FONDO OIL PAN
408	9.7625.010	FV C 10	12	rondella/washer
409	9.1770.002	FV 10	12	bullone/bolt M 8 X 1,25 X 16
410+	9.8965.032	S AC 10	1	tappo/oil drain plug
411+	9.4670.013	FV C 10	1	guarnizione/copper joint
412+	9.8965.003	FV C 10	1	tappo/plug
413+	9.4670.060	FVIC 10	1	guarnizione/copper joint
414	710.5401.011	D C 10	1	manicotto/rubber sheathing
415	9.3630.037	D C	1	fascetta/clamp
416	2830.2501.025	S AC	1	colonnetta/hollowstud
417	2830.9455.038	N	1	tubo per 3LD510/L con filtro olio est. pipe for 3LD510/L with ext.oil filter
418	283.3526.019	S C 10	4	distanziale/spacer
419+	9.1770.007	F C 10	2	bullone/bolt M 8 X 1,25 X 30
420+	9.7555.007	DV C 10	2	rondella/washer
421+	9.6780.019	D 10	2	prigioniero/stud M 8 X 30 (42)
422+	9.7555.007	DV C 10	2	rondella/washer
423+	9.3240.018	FV 10	2	dado/nut
424	9.7565.011	F C 10	8	rondella/washer
425	9.6800.004	F 10	8	prigioniero/stud M 10 X 20 (35)
426	9.3240.033	FV 10	8	dado/nut
427	283.6427.089	F IC	1	piede/engine mount
428+	500.4500.091	FV C 10	2	guarnizione/joint
429	283.5462.084	FVAC	1	marmitta/muffler std.
"	270.5460.090	F C	1	marmitta a bauletto/box form muffler
"	2830.5461.090	F C	1	marmitta avv.eletttr./elect.start.muffler
430	9.1901.054	FVIC 10	1	bullone raccordo/connection bolt 3LD510/L
431	9.4670.058	FV C 10	1	guarnizione/copper joint
432	9.4670.058	FV C 10	1	guarnizione/copper joint
433	2830.8546.021	D C	1	staffa/brace
434	9.1770.007	F C 10	2	bullone/bolt M 8 X 1,25 X 30
435	9.7625.061	D C 10	2	rondella/washer
436	273.4730.035	N 50	1	guarnizione/joint
437	2830.3902.044	S IC	1	flangia/flange
438+500+501= =9040.6745.031 FVAC			1	PRESSOSTATO COMPLETO OIL PRESSURE SWITCH
439+441= =270.3740.024 FV C			1	FILTRO OLIO ESTERNO EXTERNAL OIL FILTER
440	9.1780.003	D 10	1	bullone/bolt M 10 X 1,5 X 18
441+	270.2175.028	FV C	1	cartuccia olio/oil filter element
442	9.3240.018	FV 10	1	dado/nut
443	9.7565.011	F C 10	1	rondella/washer
444	2760.9170.018	F C	1	terminale/muffler end
445	2830.8335.073	S 10	1	spessore/spacer
446	2920.2942.050	S IC	1	curva/elbow
447	276.4500.079	FV C 10	1	guarnizione/joint
448	2830.5461.047	F C	1	marmitta/muffler
449	9.1770.006	S 10	2	bullone/bolt M 8 X 1,25 X 25
450	9.7565.007	F C 10	2	rondella/washer
451	9.3240.019	FV C 10	2	dado/nut

FIG. NO.	MATRICOLA PART NO.	Q.TA Q.TY	NOTE REMARKS	GR. 3 PAG. 14
452	90.8460.083 D	10 2	spina/locating pin	
453			
454	9.9730.027 F	10 6	vite/screw M 8 X 1,25 X 25	
455	2830.6480.038 D B	1	pignone/pinion gear	
"	283.6480.046 D A	1	"	
456	9.7565.007 F C	10 6	rondella/washer	
457	9.9730.026 F	10 6	vite/screw M 8 X 1,25 X 20	
458	500.7885.026 S I	1	scatola/case	
459	9.7565.007 F C	10 4	rondella/washer	
460	9.1770.005 F	10 4	bullone/bolt M 8 X 1,25 X 22	
461	270.5455.006 S	1	manovella/starting hand crank	
462	283.4055.003 F C	1	fune avviamento/rope starting	
463+	283.4580.001 D	50 1	guarnizione/joint 0,10	
"	283.4580.008 N	50 1	" " 0,50	
"	283.4580.012 N	50 1	" " 0,30	
"	283.4580.039 N	10 1	" " 0,05	
464	9.7625.059 D C	10 2	rondella/washer	
465	9.1760.005 FV	10 2	bullone/bolt M 6 X 1 X 16	
466+	9.7625.019 S	10 1	rondella/washer	
467	9.9730.010 S	10 2	vite/screw M 6 X 1 X 16	
468+	283.5200.159 F AC	10 1	leva/lever	
469	9.7555.007 DV C	10 2	rondella/washer	
470	9.1770.002 FV	10 2	bullone/bolt M 8 X 1,25 X 16	
471+475=			FILTRO COMBUSTIBILE ESTERNO	
=2830.3730.036 FV U		1	EXTERNAL FUEL FILTER	
472	9.4670.016 FV C	10 2	guarnizione/copper joint	
473	9.4670.016 FV C	10 2	guarnizione/copper joint	
474	9.1901.032 FVIC	10 2	bullone raccordo/connection bolt	
475+	2830.2175.045 FVAC	1	cartuccia comb./f.filter element	
476+	9.1200.041 FV	10 1	anello OR/rubber oil seal	
477	9.8430.054 D	10 2	spina/locating pin	
478	9.7565.004 F C	10 2	rondella/washer	
479	2830.9541.030 F IC	1	tubo/pipe	
480	9.7625.010 FV C	10 2	rondella/washer	
481	9.7565.007 F C	10 2	rondella/washer	
482	9.3240.019 FV C	10 2	dado/nut	
483	9.7555.004 FV C	10 3	rondella/washer	
484	9.1770.006 S	10 2	bullone/bolt M 8 X 1,25 X 25	
485	9.7555.007 DV C	10 2	rondella/washer	
486+	2830.3617.022 D C	10 1	fascetta/strip fixing	
487+	2830.9600.064 S C	1	tubetto/rubber pipe	
488+	2830.2145.003 FV C	1	cappuccio/rubber cap	
489	2830.8785.054 S C	1	supporto/support	
490	9.9730.028 F	10 2	vite/screw M 8 X 1,25 X 30	
491	9.7625.061 D C	10 2	rondella/washer	
492	9.1760.006 F I	10 1	bullone/bolt M 6 X 1 X 20	
493	9.7625.007 S C	10 1	rondella/washer	
494	2830.3500.021 S C	10 1	distanziale/spacer	
495	9.7625.007 S C	10 1	rondella/washer	
496	2830.5204.084 S C	1	leva/lever	
497	9.3203.021 D C	10 1	dado/nut	
498	9.3240.009 FV C	10 1	dado/nut	
499	70.9180.011 S C	10 1	terminale/cable-end	
500+	3600.6491.013 FVAC	1	pipetta/pipe elbow	
501+	5000.9160.056 FVAC	10 1	terminale/faston	
502	9040.2900.069 F C	1	cruscotto/dashboard	
503	9040.2900.070 F C	1	cruscotto/dashboard	
504	9040.6612.063 S AC	1	spia olio/pressure oil warning	
505	9040.6612.064 S AC	1	spia batteria/battery warning	

FIG. NO.	MATRICOLA PART NO.	Q.TA Q.TY	NOTE REMARKS	GR. 3 PAG.15
506	9040.5175.119	F AC 10 1-2	lampadina/lamp	
507	9040.2615.021	F C 1	coperchio/cover	
508	2830.5040.004	SV C 1	interruttore/key switch	
"	2760.5041.020	FV C 1	" " Bosch	
509	2760.2750.111	F C 1	coperchio/switch cover	
510	2760.5450.009	FV C 1	manometro olio/pressure gauge	
511	2760.8490.084	D 1	squadretta/angle bracket;	
512	7100.8505.085	D C 1	squadretta/angle bracket	
513+	292.5496.110	SVAC 1	per/for 3LD450-450/S-510-510/S	diam.=140
"	500.5496.113	SVAC 1	" " 3LD510/L	diam.=124
514	2920.7362.158	S C 1	regolatore a masse/weight speed govern.	
515	9.1760.005	FV 10 1	bullone/bolt M 6 X 1 X 16	
516	9.7701.014	D C 10 1	rondella/washer	
517	9.8400.056	D C 10 1	spina/taper pin	
518	270.6371.081	N 10 1	piastra/plate	
519	9.1240.005	DV C 10 1	anello seeger/snap ring	
520	270.4896.003	N 1	gruppo ingranaggio/gearwheel ass.y	
521	270.6130.036	D C 1	perno/pin	
522+523+524+525+526+			GRUPPO FORCELLA REGOLATORE	
527+528+529+530+531+			per gruppi elettrogeni	
532+533+534+535+536+			SPEED GOVERNOR YOKE ASS.Y	
537+538=			for generating sets	
=2830.4882.026 N			1	
523+	9.1165.006	D C 10 1	anello/circlip	
524+	270.6140.013	D C 10 1	perno/pin	
525+	9.3030.051	S 2	cuscinetto/ball bearing	
526+	9.8420.012	D C 10 1	spina/locking needle	
527+	283.5201.044	S C 1	leva/lever	
528+	283.6231.038	D 10 1	perno/pin	
529+	9.1165.001	S 10 1	anello/circlip	
530+	9.7625.089	N 10 1	rondella/washer	
531+	9.7555.001	N 10 1	rondella/washer	
532+	270.8785.040	D C 1	supporto/support	
533+	2830.5204.025	N 1	leva/lever	
534+	9.9800.049	N 10 1	vite/screw	
535+	283.6370.109	N 1	piastra/plate	
536+	285.6330.061	D 10 1	piastrina/safety plate	
537+	9.1755.002	D 10 1	bullone/bolt	
538+	9.1755.004	D C 10 1	bullone/bolt	
539+540+541+542+543+			SCATOLA COMANDO REGOLATORE	
544+545+550+551+552=			per gruppi elettrogeni	
=2830.2516.053 N			1 SPEED GOVER.CONTROL HOUSING for gen.sets	
540+	9.8420.012	D C 10 1	spina/locking needle	
541++540+552=			LEVA COMANDO per gruppi elettrogeni	
=283.6140.155 N			1 CONTROL LEVER for generating sets	
542+	9.3240.008	FV 10 1	dado/nut	
543+	9.3240.008	FV 10 1	dado/nut	
544+	9.1760.078	N 10 1	bullone/bolt M 6 X 1 X 45	
545+	9.1760.027	N 10 1	bullone/bolt M 6 X 1 X 40	
546	9.9800.061	F C 10 3	vite/screw	
547	2830.5680.092	N 10 1	molla/spring	
548	283.5550.017	N C 10 1	molla/spring	
549	283.5200.126	N 1	leva/lever	
550+	9.3240.019	FV C 10 1	dado/nut	
551+	2760.9180.042	S C 10 1	terminale/cable-end	

FIG. NO.	MATRICOLA PART NO.	Q.TA Q.TY	NOTE REMARKS	GR. 3 PAG.16
552+		vedi/see fig.No. 541+...	
553	283.9820.086 N	10 1	vite/screw	
554+	283.6370.114 D	C 10 1	piastra/plate	
555+554+556+557+558+ 559+560+561+562+566= =2830.2690.118 N			COPERCHIO COMANDO A MANO per gruppi elettrogeni. HAND-CONTROL LEVER for generating sets	
556+	9.7625.019 S	10 1	rondella/washer	
557+	283.5200.159 D	C 10 1	leva/lever	
558+	9.7626.054 DV	C 10 1	rondella/washer	
559+	9.7626.054 DV	C 10 1	rondella/washer	
560+	9.3240.004 FV	C 10 1	dado/nut	
561+	9.1165.001 S	10 1	anello/circlip	
562+	9.3200.015 DV	C 10 1	dado/nut	
563	283.2690.107 N		coperchio.com.dist.per gr.elettrogeni remote control cover for gen.sets	
564	9.9790.003 F	C 10 1	vite/screw	
565	45.6000.016 FV	C 10 1	pastiglia/nut	
566+	90.6330.057 F	C 10 1	piastrina/safety plate	
567	9.9732.092 F	C 10 2	vite/screw M 8 X 1,25 X 18	
568+		vedi/see fig. 9+.../95+...	
569	9.3240.018 FV	10 7	dado/nut	
570	9.7555.007 DV	C 10 7	rondella/washer	
571	9.6780.023 D	C 10 7	prigioniero/stud	
572	9.3630.008 F	C 10 1	fascetta/clamp	
573	273.7300.057 FVB	10 1	raccordo/connection	
574	292.2670.030 N		coperchio puleggia/pulley cover	
575	9.1760.094 N	10 1	bullone/bolt	
576	9.3203.050 N	10 1	dado/nut	
577	2830.5460.246 N		marmitta insonorizzata/silenced muffler	
578	9.7565.007 F	C 10 1	rondella/washer	
23+87+204+211+222+ 225+247+302+305+307+ 326+406+428+463= =283.8180.033 FV CR			SERIE GUARNIZIONI GASKET SET	

DISVI/RICA

21.11.1986

DESCRIZIONI NON IMPEGNATIVE
SUBJECT TO MODIFICATIONS

aggiornata al 21.11.1986

MATERIALE DI RETTIFICA
GRINDING WORKSHOP PARTS LIST
MATERIEL POUR RECTIFIEUR

GR. 03
PAG.17

MOTORI-ENGINES-MOTEURS GR. 3

FIG. NO.	MATRICOLA PART NO.	Q.TA Q.TY	NOTE REMARKS
100+	283.9652.017 FV CR10	1	valvola aspirazione/inlet valve
101+	283.9685.027 FV CR10	1	valvola scarico/exhaust valve
190+	285.4845.053 FV CR10	1	guida v.aspir./inlet v.guide std.
"	285.4845.058 FV CR10	1	" " " " +0,50
192+	285.4845.050 FV CR10	1	guida v.scarico/exhaust v.guide std.
"	285.4845.059 FV CR10	1	" " " " +0,50
200+201+202+203=			PISTONE COMPLETO/PISTON SET
	=283.6501.045 F CR	1	+0,50 per/for 3LD450-450/S
	=283.6501.046 F CR	1	+1,00 " " " "
	=292.6501.074 F CR	1	+0,50 per/for 3LD510-510/S-510/L
	=292.6501.075 F CR	1	+1,00 " " " "
201+	283.8210.056 F CR10	1	+0,50 serie segm./ring set(4 seg./rings)
"	283.8210.057 F CR10	1	+1,00 " " " "
"	283.8211.010 F ACR10	1	+0,50 " " " " (3 seg./rings)
"	283.8211.011 F CR10	1	+1,00 " " " "
223+	283.8000.036 FV CR10	1	sede v.aspirazione/inlet v.seat
226+	283.8000.037 FV CR10	1	sede v.scarico/exhaust v.seat
235+	271.1630.007 FV CR	1	bronz.piede biella/small end bearing
237	271.1640.028 F CR	1	bronz.biella/large end bushing -025.
"	271.1640.029 F CR	1	" " " " -0,50
270	271.1710.049 F ICR	1	bronz./bearing -1,00 3LD450-510-510/L
312	283.1610.067 F CR	1	bronz.lato distr./gear side bear. -1,00
322	271.1610.024 F CR	1	bronz.lato volano/flywh.side bear.-1,00
23+87+204+211+222+ 225+247+302+305+307+ 326+406+428+463=			SERIE GUARNIZIONI GASKET SET
	=283.8180.033 FV CR	1	

