

PNC	ML	Model	Brand
967174401	03	M46-125R	McCulloch

Number of Pages 1 of 3

Factory:	IIQ - Valmadrera	Product Group:	OP 93
Publication Number:	MIPL2012_V510000005	Petrol Portable	
Publication Date:	21/12/12	Sub Group	1071

HUSQVARNA ITALIA SPA

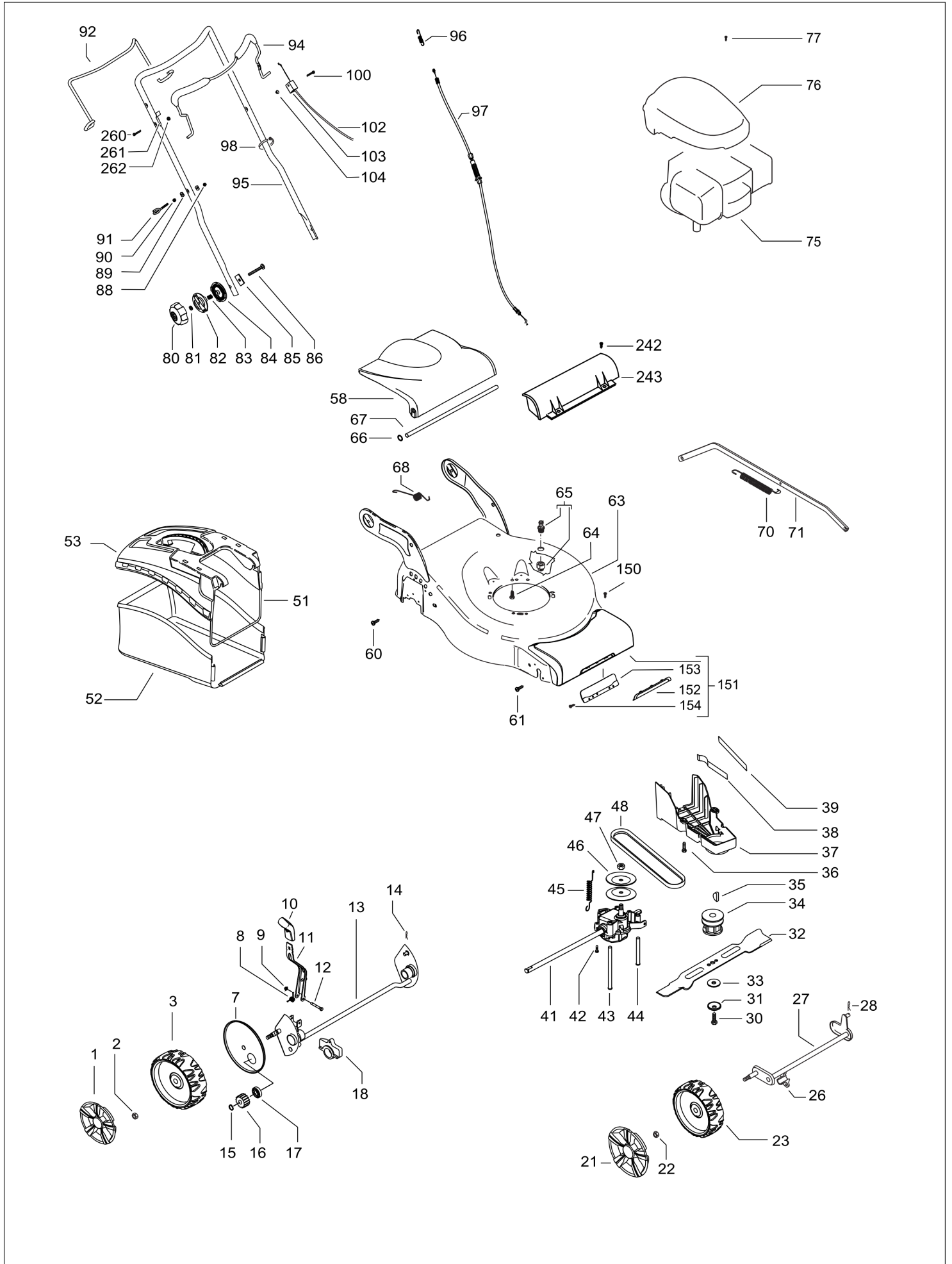

HUSQVARNA ITALIA SPA

Item	PN	Description	Qty	Item	PN	Description	Qty
1	574 39 65-01	wheel cover Ø210	2	64	531 21 28-51	screw 3/8" + split washer	3
2	504 85 78-01	nut M8, self locking, flanged	2	65	531 20 58-48	snap on connector 1/2"	1
3	574 41 52-02	wheel assy Ø210	2	66	531 20 76-57	starlock	2
7	504 82 73-01	dust shield	2	67	531 21 14-41	safety flap bar	1
8	531 21 08-17	spring, wheel regulator lever	1	68	531 21 18-40	spring	1
9	531 20 84-92	nut M5	1	70	579 24 53-02	wheel regulation spring	1
10	580 46 24-01	handle, wheel regulator	1	71	580 96 33-01	wheel regulation bar	1
11	581 17 86-01	wheel regulator lever	1	75	————	engine, Briggs & Stratton, model number 08P5020005H1	1
12	538 23 58-07	screw M5x45, self threading	1	76	580 44 56-01	engine shroud	1
13	504 80 01-01	rear axle	1	77	532 18 16-98	engine shroud screw	3
14	531 20 66-53	cotter pin	1	80	580 42 43-01	knob	2
15	531 20 87-72	seeger	2	81	531 20 49-22	washer	2
16	544 34 23-01	gear	2	82	531 21 14-74	locking disc, outer	2
17	531 20 87-78	ball bearing	2	83	531 21 14-76	spring	2
18	531 20 59-44	rear axle housing	2	84	531 21 14-73	locking disc, inner	2
21	574 39 64-01	wheel cover Ø190	2	85	531 21 15-81	plate	2
22	504 85 78-01	nut M8, self locking, flanged	2	86	581 25 95-01	screw M8x55	2
23	574 41 50-02	wheel assy Ø190	2	88	531 20 84-91	nut M6 self	1
26	577 38 42-01	front axle housing	2	89	531 20 49-61	washer	2
27	504 85 65-01	front axle	1	90	531 20 71-65	nut M6	1
28	531 20 66-53	cotter pin	1	91	531 20 51-69	starter cable guide	1
30	531 20 80-08	screw, 3/8"	1	92	580 65 43-01	clutch lever	1
31	531 20 72-37	spring washer	1	94	580 84 91-04	brake lever	1
32	531 21 10-17	blade	1	95	580 41 23-02	handle	1
33	531 20 72-43	washer	1	96	580 76 19-01	spring, clutch	1
34	581 84 30-01	blade support	1	97	544 90 80-04	clutch cable	1
35	505 29 09-01	key	1	98	531 20 55-81	zip tie	2
36	531 20 78-56	screw 5x10	3	100	580 83 36-01	screw	1
37	544 46 22-01	belt cover	1	102	580 85 34-01	brake cable	1
38	504 04 61-01	belt guide	1	103	531 20 80-43	cable support	1
39	544 46 25-01	belt guide	1	104	581 55 12-01	nut	1
41	544 34 32-03	gear box	1	150	576 04 74-01	screw	2
42	510 03 75-01	screw 4x16, self threading	2	151	575 56 21-04	front cover	1
43	544 93 44-01	belt guide	1	152	574 37 52-01	front cover plate	1
44	544 93 43-01	belt guide	1	153	574 72 17-01	back plate	1
45	544 93 47-01	gear box spring	1	154	575 95 57-01	screw	2
46	504 54 79-01	pulley plate	2	242	576 04 74-01	screw M5x16	2
47	504 54 80-01	nut	1	243	579 30 09-01	grass seal	1
48	504 03 48-01	belt Z28 10X710	1	260	580 83 36-02	screw	1
51	574 86 94-01	sack frame	1	261	532 43 00-34	brake lever support	1
52	574 86 96-02	sack	1	262	581 55 12-01	nut	1
53	574 61 03-01	hard top	1				
58	574 61 02-01	safety flap	1				
60	531 20 66-77	screw 4.8x19, self threading	2				
61	525 43 31-01	screw 4x16, self threading	4				
63	581 29 20-02	deck	1				