

MODEL 405019x50A

REPAIR PARTS CHASSIS & HOOD

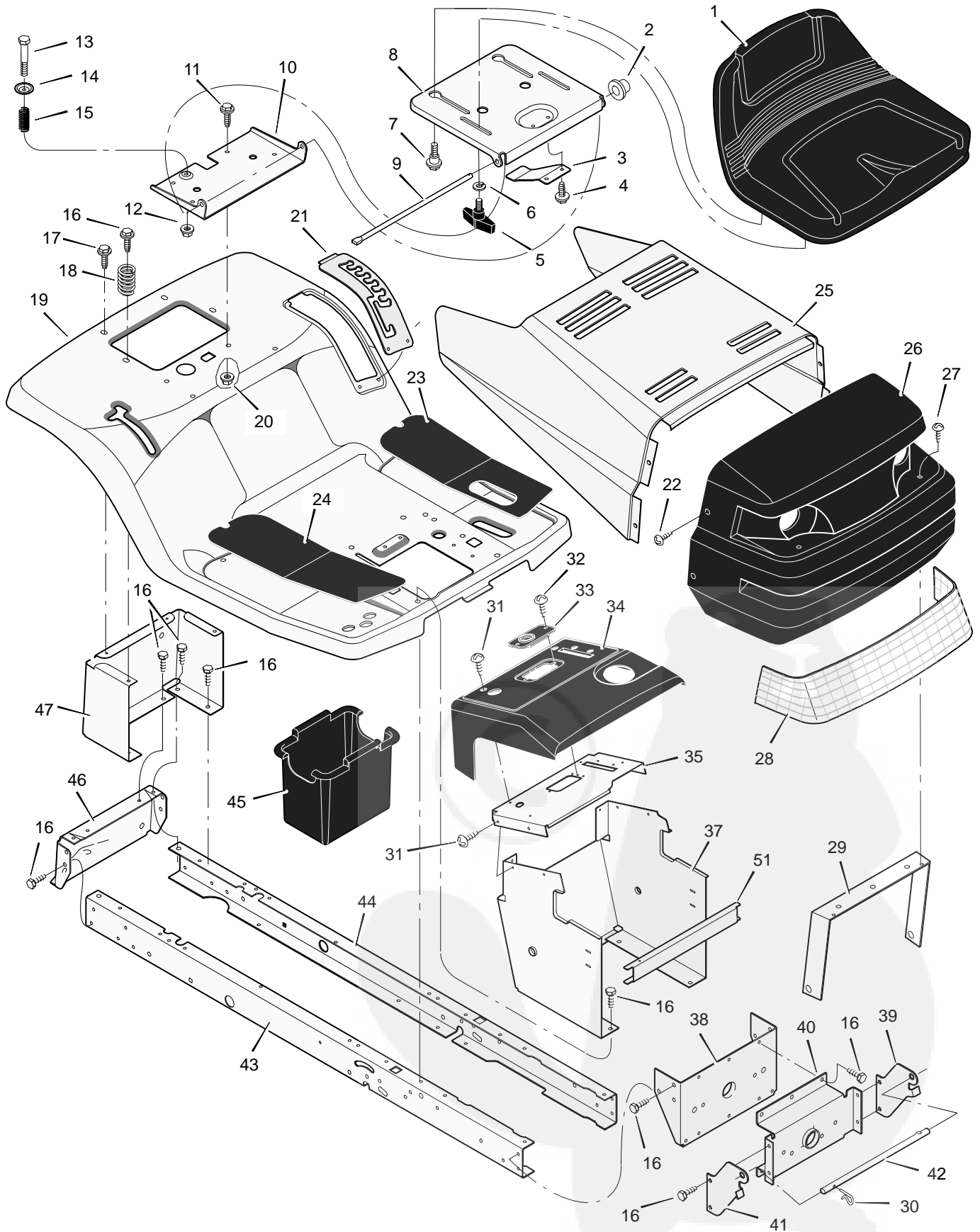

MODEL 405019x50A

REPAIR PARTS CHASSIS & HOOD

Key No.	Description	Part No.	Key No.	Description	Part No.
1	Seat	690567	26	Grille Assembly (Includes Lens)	94867E700
2	Cap, Push On	28x23	27	Screw	26x239
3	Spring	94057	28	Lens	92334
4	Screw	26x229	29	Brace, Grille	92448
5	Bolt, Wing	1001054	30	Pin, Hair	31x4
6	Washer	17x47	31	Screw	26x270
7	Bolt, Shoulder	9x56	32	Screw	26x239
8	Support, Seat	94154E700	33	Bearing, Steering	94214
9	Rod, Pivot	94156 Z	34	Dash	95033E700
10	Bracket, Pivot	94153E700	35	Plate, Dash	94211E700
11	Bolt	1x45	36	Panel, Access	93007E700
12	Nut	15x89	37	Support, Dash	95323E700
13	Bolt, Shoulder	9x55	38	Bracket, Rear Hanger	94013E700
14	Washer	94155 Z	39	Support, Left Grille	94213E700
15	Spring	164x31	40	Axle, Hanger	94007E700
16	Screw	26x249	41	Support, Right Grille	94212E700
17	Screw	26x263	42	Rod, Pivot	92332 Z
18	Spring	164x30	43	Frame, Right	1001124E700
19	Deck, Seat	95249E245	44	Frame, Left	1001123E700
20	Nut	15x88	45	Container, Battery	690424
21	Plate, Index	94829E700	46	Plate, Hitch	1001002E700
23	Mat, Left	94999	47	Panel, Rear	690434E700
24	Mat, Right	94998	51	Channel	94215E700
25	Hood	92333E245	—	Instruction Book & Parts List	F-010740L

MODEL 405019x50A

REPAIR PARTS MOTION DRIVE

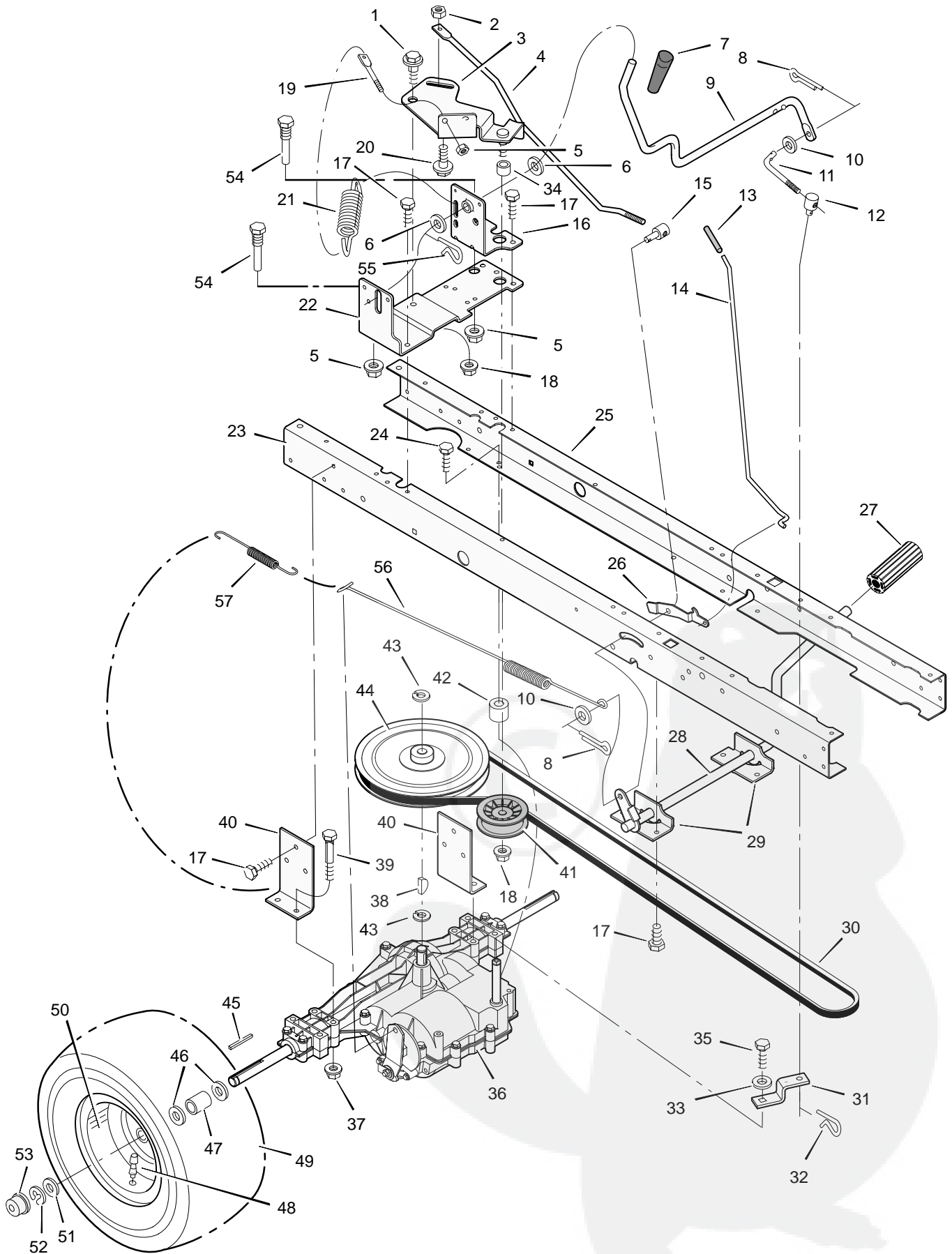

MODEL 405019x50A

REPAIR PARTS MOTION DRIVE

Key No.	Description	Part No.	Key No.	Description	Part No.
1	Bolt, Shoulder	9x39	30	Belt, Motion Drive	37x87
2	Nut, Hex	15x89	31	Yoke, Shift	94031Z
3	Arm, Idler	690173 Z	32	Pin, Hair	31x6
4	Rod, Clutch	94041 Z	33	Washer	17x148
5	Nut	15x79	34	Spacer	690369
6	Washer	17x102	35	Bolt	6x105
7	Grip	92697	36	Transaxle **	—
8	Pin, Cotter	30x20	37	Nut	15x88
9	Lever, Shift	94043 Z	38	Key, Woodruff	20697
10	Washer	17x47 Z	39	Bolt	1x155
11	Link, Shift	94044 Z	40	Bracket, Transaxle	94008E700
12	Nut, Adjuster	21920	41	Pulley	690409
13	Grip	91079	42	Spacer	94132
14	Rod, Parking Brake	95005 Z	43	E-Ring	11x7
15	Nut, Adjuster	94815	44	Pulley, Drive	95094
16	Bracket, Shift	94034E700	45	Key, Square	21553
17	Screw	26x249	46	Washer	17x160
18	Nut	15x84	47	Spacer, Transaxle	690554 Z
19	Mount, Stud Spring	94042 Z	48	Stem, Valve	24373
20	Bolt, Shoulder	9x54	49	Tire *	24375
21	Spring, Extension	165x116	—	Tube	407049
22	Bracket, Shifter	690166E700	50	Wheel & Tire Assembly	92294-601
23	Frame, Right	690206E700	51	Washer	17x195
24	Screw	25x12	52	E-Ring	11x3
25	Frame, Left	690207E700	53	Hub Cap	94618
26	Latch, Parking Brake	94045 Z	54	Guide, Belt	93349
27	Pedal	21544	55	Pin, Hair	31x4
28	Lever, Brake/Clutch	94038E700	56	Spring, Extension	165x115
29	Bracket, Pedal	1001117E700	57	Spring, Extension	165x92

* When you order a tire, make sure to give the brand name of the tire so that the tread pattern on the tire will match.

** For information on Replacement Parts see the Central Parts Distributor in your area.

MODEL 405019x50A

REPAIR PARTS STEERING

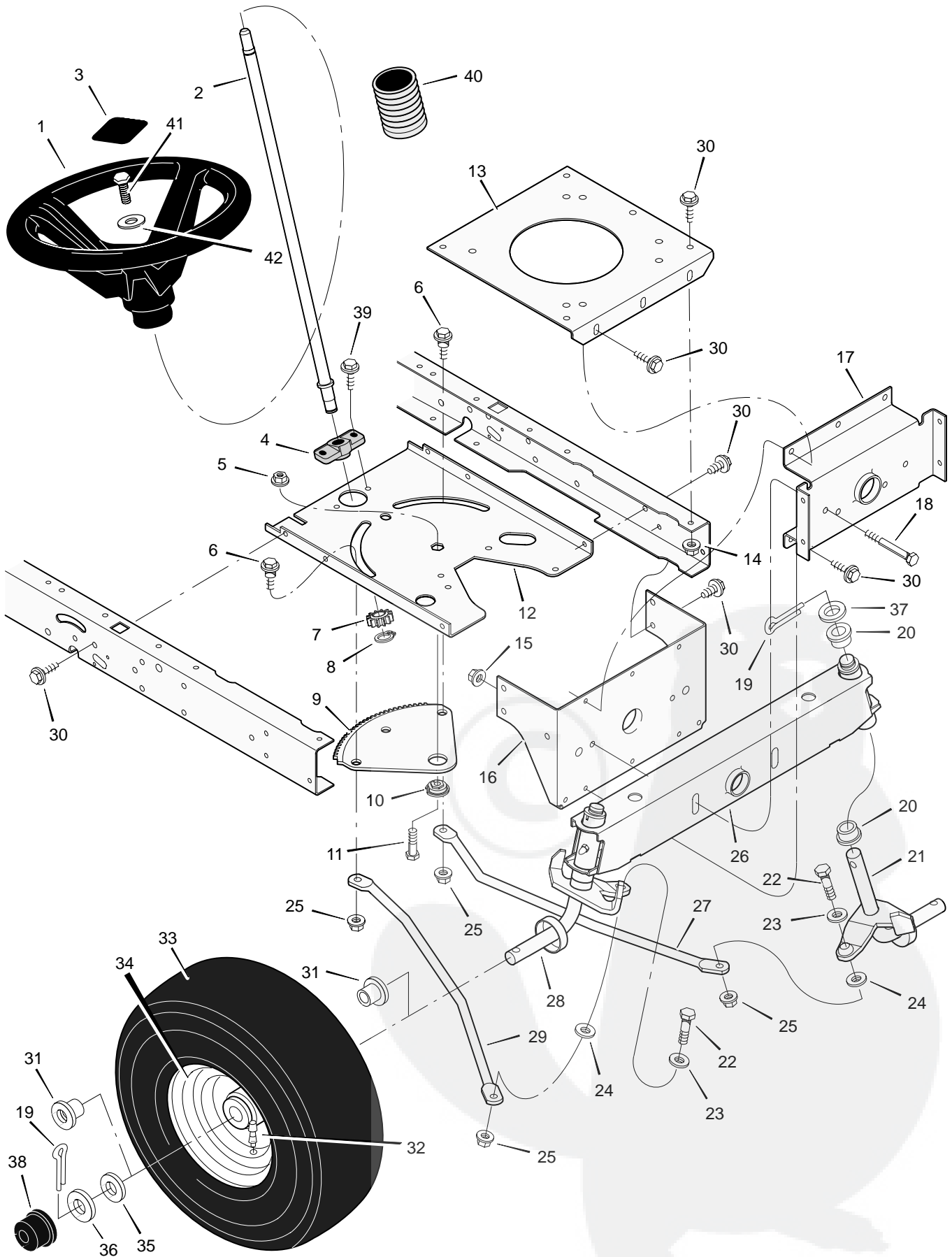

MODEL 405019x50A

REPAIR PARTS STEERING

Key No.	Description	Part No.	Key No.	Description	Part No.
1	Wheel, Steering	95184	23	Washer	17x104
2	Post, Steering	690626	24	Washer	17x53 Z
3	Insert, Steering Wheel	711325	25	Nut, Flange	15x84
4	Bearing	94124	26	Axle Assembly	690210E700
5	Nut, Flange	15x111	27	Drag Link, Left	95329E700
6	Bolt, Shoulder	9x57	28	Spindle Assembly, Right	94575E700
7	Gear, Pinion	690183E700	29	Drag Link, Right	95328E700
8	Ring, Snap	11x25	30	Screw	26x249
9	Gear, Sector	94121E700	31	Bearing, Wheel	91334
10	Bearing	94123	32	Stem, Valve	24373
11	Bolt	1x84	33	Tire *	24380
12	Plate, Steering	1001121E700	—	Tube	407924
13	Plate, Engine	94006E700	34	Wheel and Tire Assembly	94580-601
14	Nut, Flange	15x88	35	Washer	17x195
15	Nut, Flange	15x118	36	Washer	17x192
16	Bracket, Hanger	94013E700	37	Washer	17x113
17	Axle, Hanger	94007E700	38	Hub Cap	94618
18	Bolt	1x146	39	Screw	26x267
19	Pin, Cotter	30x49	40	Bellows	54789
20	Bearing	690150	41	Bolt	25x3
21	Spindle Assembly, Left	94576E700	42	Washer	17x146
22	Bolt	1x111			

* When you order a tire, make sure to give the brand name of the tire so that the tread pattern on the tire will match.

MODEL 405019x50A

REPAIR PARTS MOWER HOUSING SUSPENSION

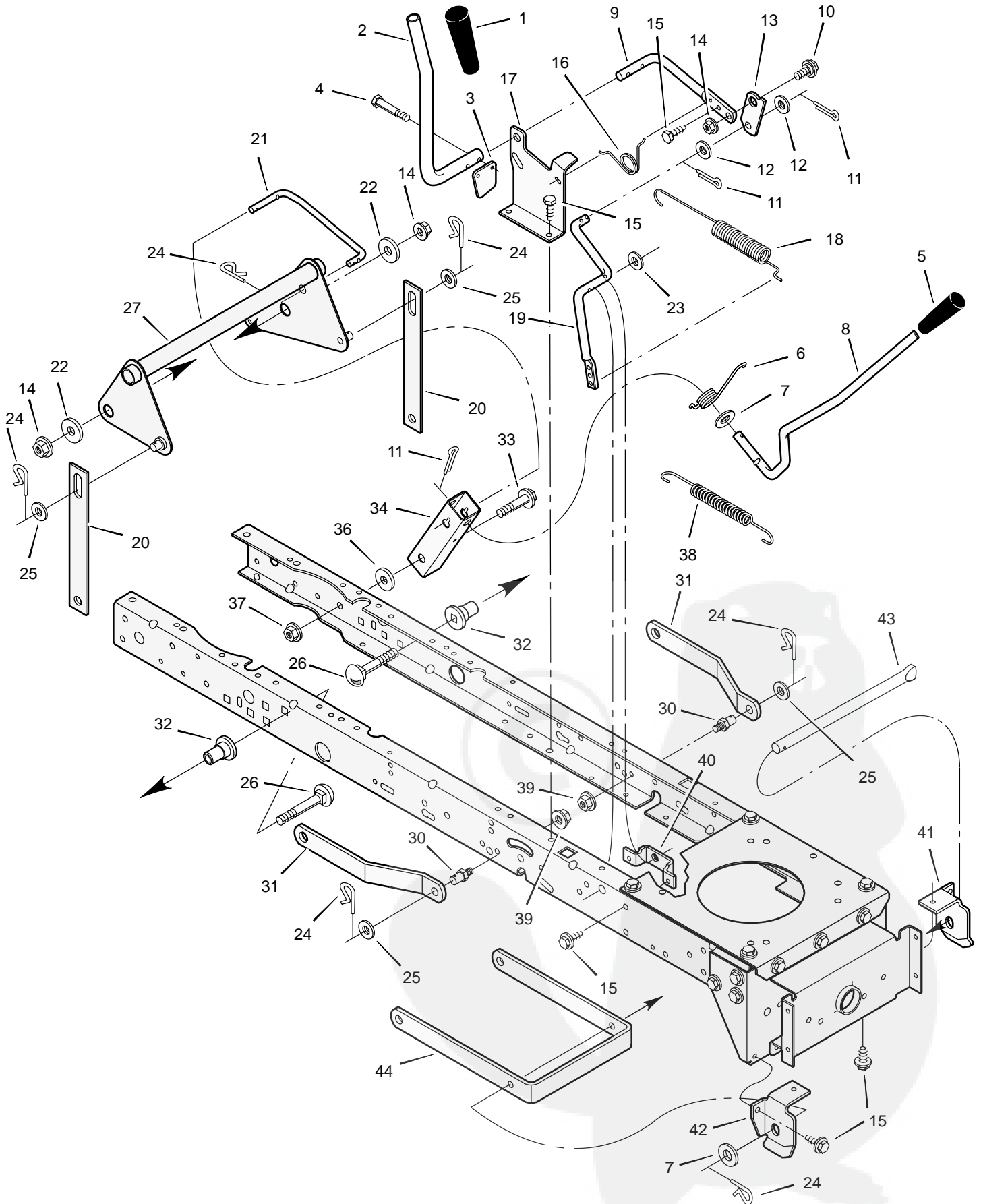

MODEL 405019x50A

REPAIR PARTS MOWER HOUSING SUSPENSION

Key No.	Description	Part No.	Key No.	Description	Part No.
1	Grip	92698	22	Washer	17x168
2	Handle, PTO	94346 Z	23	Washer	17x57
3	Pad, Switch	94022 Z	24	Pin, Hair	31x4
4	Bolt	25x3	25	Washer	17x91
5	Grip	92697	26	Bolt, Carriage	2x85
6	Spring	166x40	27	Lever Assembly, Lift	1001111E700
7	Washer	17x103	30	Pin	94067
8	Handle, Lift	690533	31	Bracket, Rear Suspension	94055E700
9	Lever, PTO	94017 Z	32	Spacer, Lifter	690151
10	Bolt, Shoulder	9x39	33	Bolt, Shoulder	9x53
11	Pin, Cotter	30x20	34	Bracket, Pivot	94015E700
12	Washer	17x102	36	Washer	17x191
13	Link, PTO	94004 Z	37	Nut, Flange	15x84
14	Nut, Flange	15x84	38	Spring	165x131
15	Screw	26x249	39	Nut, Flange	15x68
16	Spring	166x39	40	Bracket, PTO	94005E700
17	Bracket, PTO	94018E700	41	Hanger, Left Deck	94027E700
18	Spring	165x118	42	Hanger, Right Deck	94026E700
19	Crank, PTO	690394E700	43	Rod, Hanger	94158Z
20	Link, Lift	690212E700	44	Bracket, Suspension	94058E700
21	Link, Lift Handle	690122E700			

MODEL 405019x50A

REPAIR PARTS MOWER HOUSING

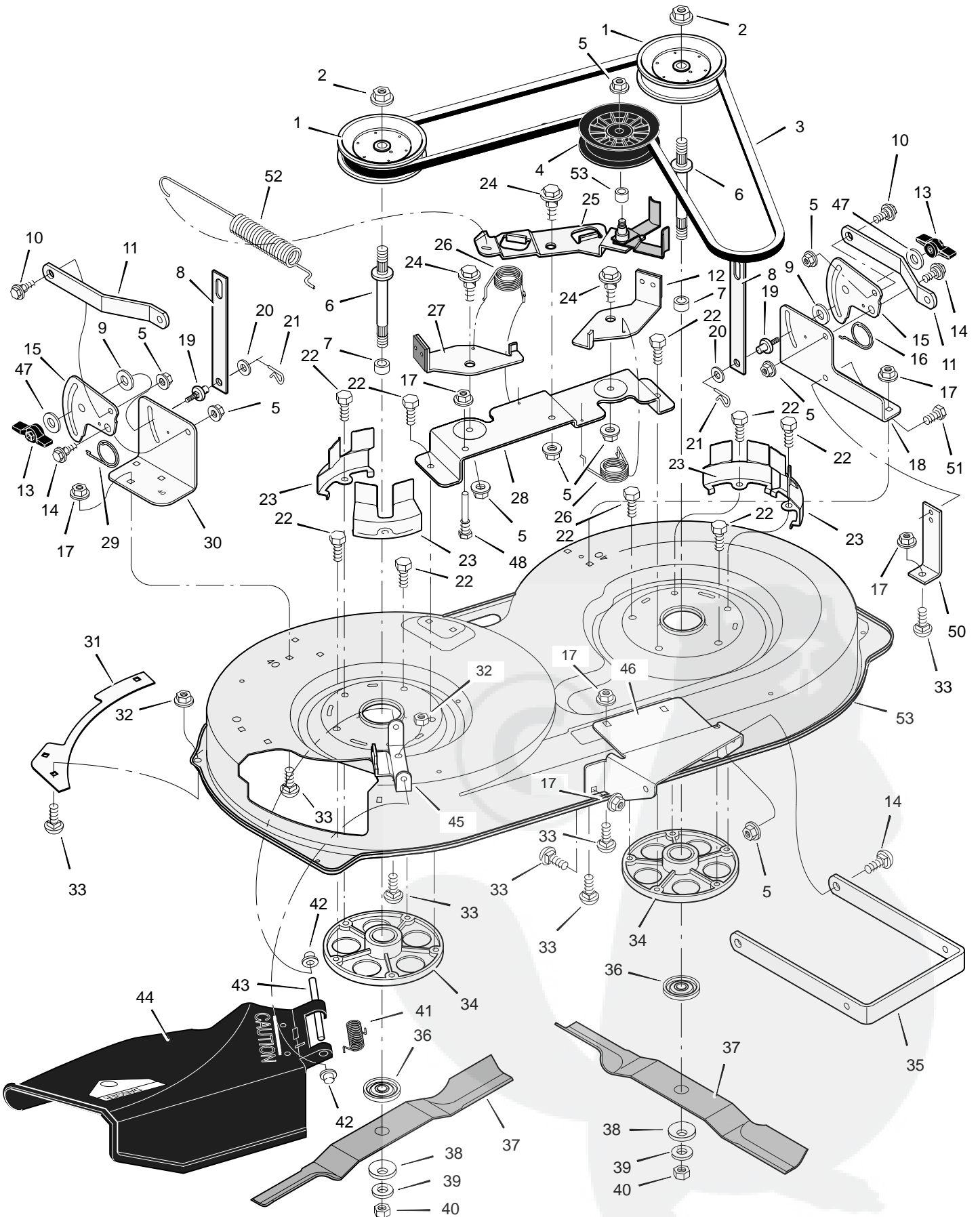

MODEL 405019x50A

REPAIR PARTS MOWER HOUSING

Key No.	Description	Part No.	Key No.	Description	Part No.
1	Pulley, Jackshaft	92851	28	Bracket Assembly, Brake	94145E700
2	Nut, Hex	15x121	29	Spring	166x42
3	Belt, Mower Drive	37x62	30	Bracket, Suspension	94142E700
4	Pulley, Idler	690387	31	Plate	91770E700
5	Nut, Flange	15x84	32	Nut, Flange	15x88
6	Jackshaft	94129	33	Bolt, Carriage	2x53
7	Spacer	94130	34	Mandrell	690222
8	Link, Lift	690212E700	35	Bracket, Suspension	94058E700
9	Pad, Friction	94137	36	Adapter, Blade	1001035
10	Bolt, Shoulder	9x52	37	Blade	92002E701
11	Bracket, Suspension	94055E700	38	Washer	17x166
12	Pad Assembly, Left Brake	94049E700	39	Washer	17x165
13	Knob	94068	40	Nut	15x100
14	Bolt, Shoulder	9x51	41	Spring	166x4
15	Plate, Suspension	94128E700	42	Cap, Push On	28x23
16	Spring	166x43	43	Rod, Pivot	94957 Z
17	Nut, Flange	15x79	44	Deflector Assembly	94707
18	Bracket, Left Suspension	94143E700	45	Bracket, Deflector	94956E700
19	Pin, Hanger	95194	46	Bracket, Front Hanger	94144E700
20	Washer	17x103	47	Washer	17x45 Z
21	Pin, Cotter	31x4	48	Guide, Belt	94781
22	Bolt	25x7	50	Bracket, Support	94681E700
23	Cover, Pulley	94051E700	51	Screw	26x249
24	Bolt, Shoulder	9x39	52	Spring, Extension	165x119
25	Arm, Idler	690408E700	53	Spacer	690369
26	Spring	166x41	54	Housing, Blade *	94141E700
27	Pad Assembly, Right Brake	94047E700	1-54	Complete Mower Housing Assembly	776001

* Includes Key No. 17, 18, 30, 31, 32, 33, 45, 46, 47 and 51.

MODEL 405019x50A

REPAIR PARTS ENGINE MOUNT

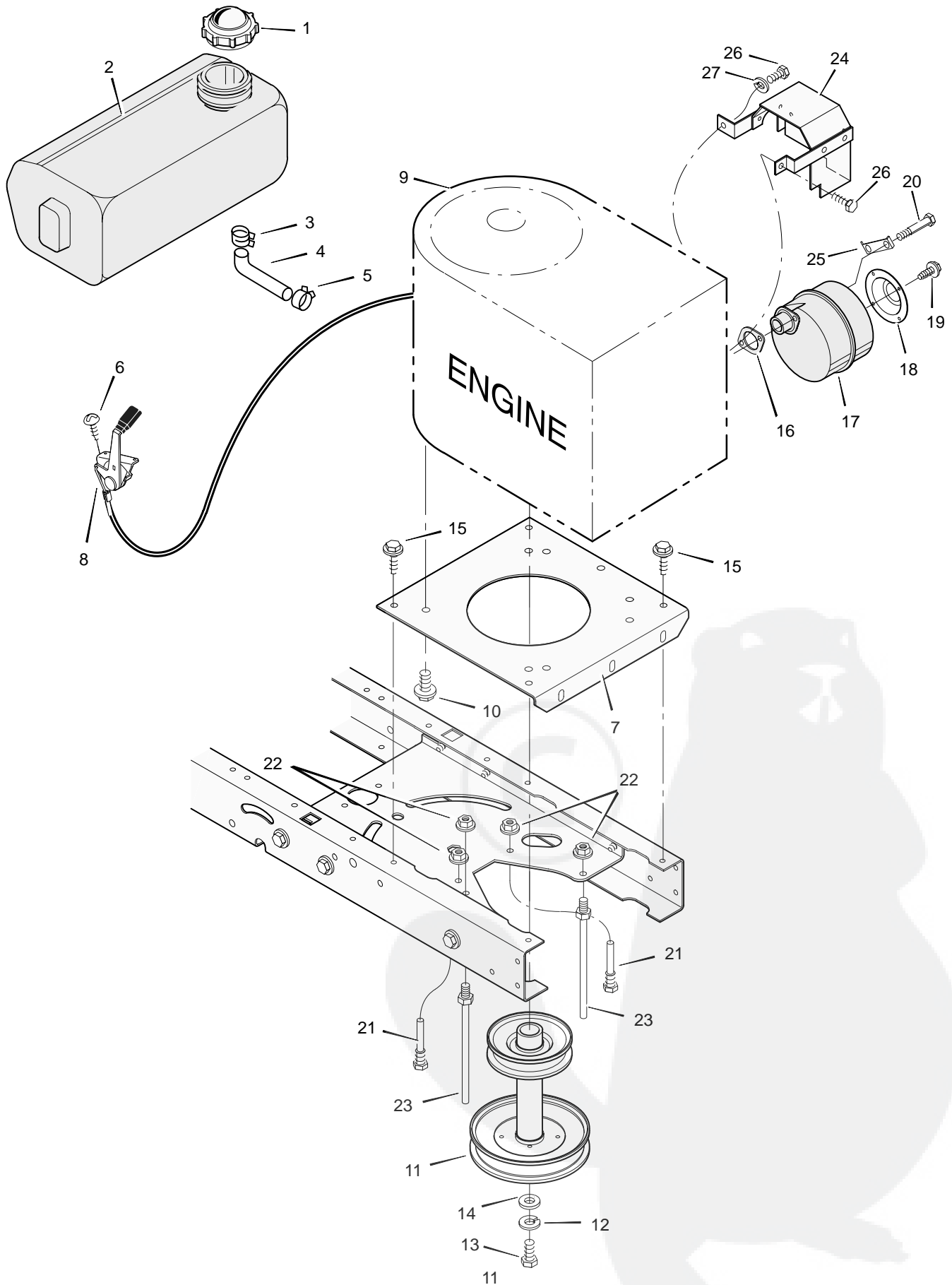

MODEL 405019x50A

REPAIR PARTS ENGINE MOUNT

Key No.	Description	Part No.
1	Fuel Cap	92317
2	Fuel Tank	92342
3	Hose Clamp	95197
4	Fuel Line	23717
5	Hose Clamp	95197
6	Screw	26x201
7	Plate, Engine	94006E700
8	Throttle Control	92371
9	Engine*	—
10	Bolt, Engine Mount	25x7
11	Stack Pulley Assembly	690439 Z
12	Lockwasher	19x35
13	Bolt, Hex	1x140
14	Washer	18x32
15	Screw	26x249
16	Gasket	91309
17	Muffler	91271
18	Deflector, Muffler	94099 Z
19	Screw	26x208
20	Bolt, Hex	1x134
21	Guide, Belt	93349
22	Nut, Flange	15x79 Z
23	Guide, Belt	94066
24	Shield, Heat	92381
25	Lock, Screw	92378
26	Screw	26x263
27	Washer	18X32

* Parts are available from an engine Authorized Service Center. See "Engines, Gasoline" or "Gasoline Engines" in the yellow pages of the telephone directory.

MODEL 405019x50A

REPAIR PARTS ELECTRICAL SYSTEM

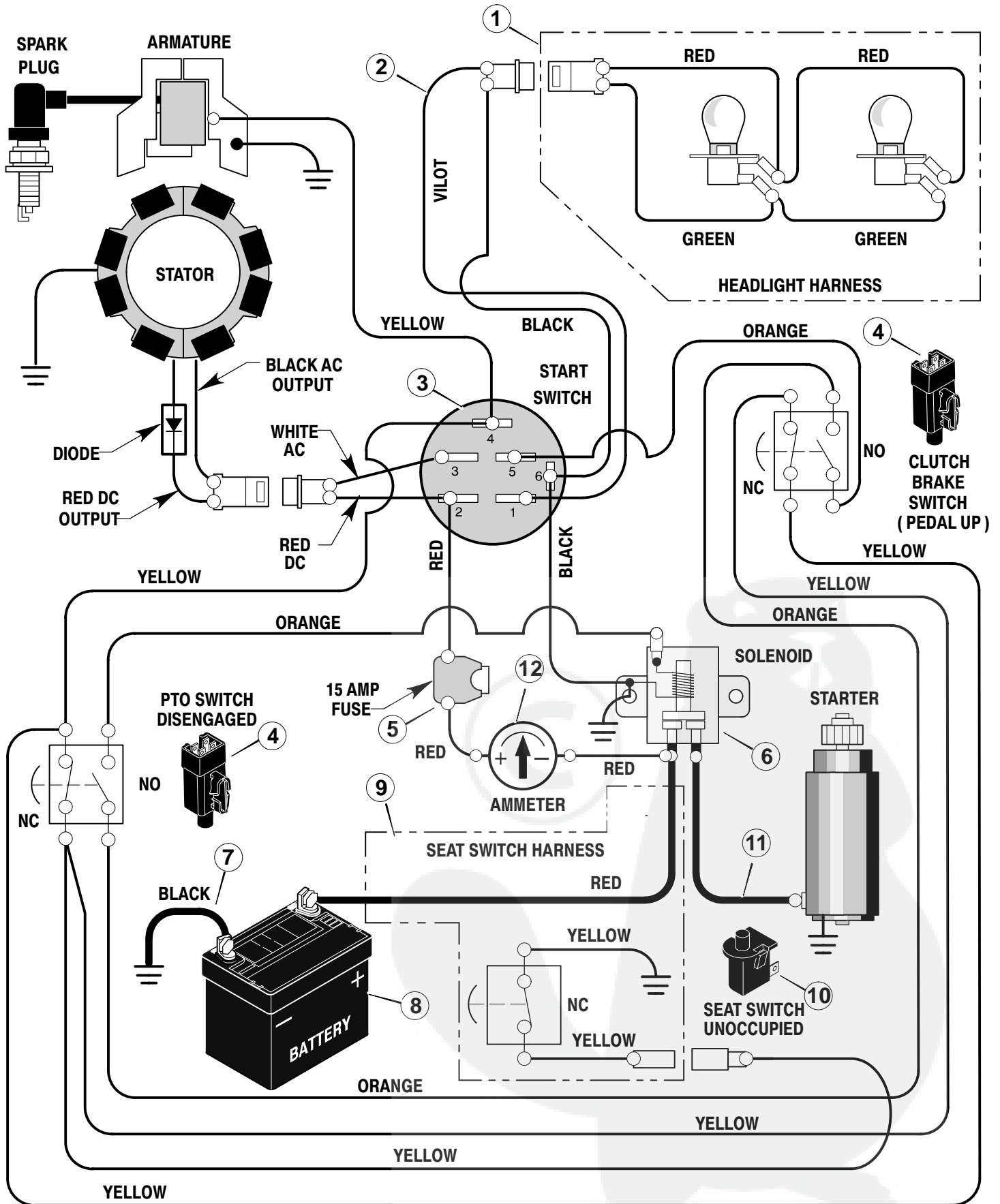

Key No.	Description	Part No.
1	Harness, Light Wire	250x92
	Socket, Light	092372
	Bulb, Light	090084
2	Harness, Chassis Wire	250x86
3	Switch, Ignition	092377
	Key, Ignition	020729
	Nut, Hex	091489
	Cap, Ignition	091488
4	Switch, Limit	094136
5	Fuse	054212
	Holder, Fuse	407078
6	Solenoid	094613
	Screw, Mounting	26x229
	Locknut	15x116
7	Cable, Battery Ground	024x32
	Screw, Ground Cable	26x213
8	Battery	021075SE
	Bolt, Carriage	002x82
	Wingnut	014x79
9	Harness, Seat Switch Wire	250x67
10	Switch, Seat Sensor	094159
11	Cable	024x31